



7-INCH AUDIO/VIDEO RECEIVER  
**iLX-W660E**

EN

TH

ID

VI



**androidauto™**



QUICK REFERENCE GUIDE

คู่มืออ้างอิงฉบับย่อ

PANDUAN REFERENSI SINGKAT

HƯỚNG DẪN THAM KHẢO NHANH



# Contents

WARNING .....	2
CAUTION .....	3
Getting Started .....	4
Apple CarPlay Operation (Optional).....	6
Android Auto™ (Optional).....	6
Radio Operation .....	7
USB Flash drive Operation (Optional).....	7
iPod mode on iPhone (Optional).....	8
Hands-Free Phone Control .....	9
Installation.....	10
Connections.....	12
Specifications .....	14

## IMPORTANT

Please record the serial number of your unit in the space provided below and keep it as a permanent record.

SERIAL NUMBER: \_\_\_\_\_

INSTALLATION DATE: \_\_\_\_\_

INSTALLATION TECHNICIAN: \_\_\_\_\_

PLACE OF PURCHASE: \_\_\_\_\_

For details on all functions, refer to the Owner's Manual.

## WARNING



### WARNING

**This symbol means important instructions. Failure to heed them can result in serious injury or death.**

#### **INSTALL THE PRODUCT CORRECTLY SO THAT THE DRIVER CANNOT WATCH TV/VIDEO UNLESS THE VEHICLE IS STOPPED AND THE EMERGENCY BRAKE IS APPLIED.**

It is dangerous for the driver to watch TV/Video while driving a vehicle. Installing this product incorrectly enables the driver to watch TV/Video while driving. This may cause a distraction, preventing the driver from looking ahead, thus causing an accident. The driver or other people could be severely injured.

#### **DO NOT WATCH VIDEO WHILE DRIVING.**

Watching the video may distract the driver from looking ahead of the vehicle and cause an accident.

#### **DO NOT OPERATE ANY FUNCTION THAT TAKES YOUR ATTENTION AWAY FROM SAFELY DRIVING YOUR VEHICLE.**

Any function that requires your prolonged attention should only be performed after coming to a complete stop. Always stop the vehicle in a safe location before performing these functions. Failure to do so may result in an accident.

#### **KEEP THE VOLUME AT A LEVEL WHERE YOU CAN STILL HEAR OUTSIDE NOISES WHILE DRIVING.**

Excessive volume levels that obscure sounds such as emergency vehicle sirens or road warning signals (train crossings, etc.) can be dangerous and may result in an accident. LISTENING AT LOUD VOLUME LEVELS IN A CAR MAY ALSO CAUSE HEARING DAMAGE.

#### **MINIMIZE DISPLAY VIEWING WHILE DRIVING.**

Viewing the display may distract the driver from looking ahead of the vehicle and cause an accident.

#### **DO NOT DISASSEMBLE OR ALTER.**

Doing so may result in an accident, fire or electric shock.

#### **USE ONLY IN CARS WITH A 12 VOLT NEGATIVE GROUND.**

(Check with your dealer if you are not sure.) Failure to do so may result in fire, etc.

#### **KEEP SMALL OBJECTS SUCH AS SCREWS OUT OF THE REACH OF CHILDREN.**

Swallowing them may result in serious injury. If swallowed, consult a physician immediately.

#### **USE THE CORRECT AMPERE RATING WHEN REPLACING FUSES.**

Failure to do so may result in fire or electric shock.

#### **DO NOT BLOCK VENTS OR RADIATOR PANELS.**

Doing so may cause heat to build up inside and may result in fire.

#### **USE THIS PRODUCT FOR MOBILE 12V APPLICATIONS.**

Use for other than its designed application may result in fire, electric shock or other injury.

#### **MAKE THE CORRECT CONNECTIONS.**

Failure to make the proper connections may result in fire or product damage.

#### **BEFORE WIRING, DISCONNECT THE CABLE FROM THE NEGATIVE BATTERY TERMINAL.**

Failure to do so may result in electric shock or injury due to electrical shorts.

#### **DO NOT ALLOW CABLES TO BECOME ENTANGLED IN SURROUNDING OBJECTS.**

Arrange wiring and cables in compliance with the manual to prevent obstructions when driving. Cables or wiring that obstruct or hang up on places such as the steering wheel, gear lever, brake pedals, etc. can be extremely hazardous.

#### **DO NOT SPLICE INTO ELECTRICAL CABLES.**

Never cut away cable insulation to supply power to other equipment. Doing so will exceed the current carrying capacity of the wire and result in fire or electric shock.

#### **DO NOT DAMAGE PIPE OR WIRING WHEN DRILLING HOLES.**

When drilling holes in the chassis for installation, take precautions so as not to contact, damage or obstruct pipes, fuel lines, tanks or electrical wiring. Failure to take such precautions may result in fire.

#### **DO NOT USE BOLTS OR NUTS IN THE BRAKE OR STEERING SYSTEMS TO MAKE GROUND CONNECTIONS.**

Bolts or nuts used for the brake or steering systems (or any other safety-related system), or tanks should NEVER be used for installations or ground connections. Using such parts could disable control of the vehicle and cause fire etc.

#### **DO NOT INSTALL IN LOCATIONS WHICH MIGHT HINDER VEHICLE OPERATION, SUCH AS THE STEERING WHEEL OR SHIFT LEVER.**

Doing so may obstruct forward vision or hamper movement etc. and results in serious accident.



## CAUTION

**This symbol means important instructions. Failure to heed them can result in injury or material property damage.**

---

### **HALT USE IMMEDIATELY IF A PROBLEM APPEARS.**

Failure to do so may cause personal injury or damage to the product. Return it to your authorized Alpine dealer or the nearest Alpine Service Center for repairing.

---

### **HAVE THE WIRING AND INSTALLATION DONE BY EXPERTS.**

The wiring and installation of this unit requires special technical skill and experience. To ensure safety, always contact the dealer where you purchased this product to have the work done.

---

### **USE SPECIFIED ACCESSORY PARTS AND INSTALL THEM SECURELY.**

Be sure to use only the specified accessory parts. Use of other than designated parts may damage this unit internally or may not securely install the unit in place. This may cause parts to become loose resulting in hazards or product failure.

---

### **ARRANGE THE WIRING SO IT IS NOT CRIMPED OR PINCHED BY A SHARP METAL EDGE.**

Route the cables and wiring away from moving parts (like the seat rails) or sharp or pointed edges. This will prevent crimping and damage to the wiring. If wiring passes through a hole in metal, use a rubber grommet to prevent the wire's insulation from being cut by the metal edge of the hole.

---

### **DO NOT INSTALL IN LOCATIONS WITH HIGH MOISTURE OR DUST.**

Avoid installing the unit in locations with high incidence of moisture or dust. Moisture or dust that penetrates into this unit may result in product failure.

---

## Getting Started

### Controls Position

The screen design used in the Quick Reference Guide may differ from the actual screen.

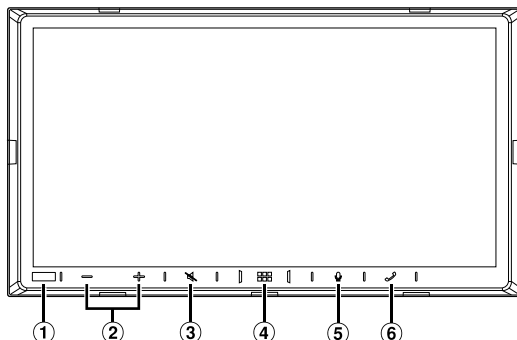

- ① **Dimmer Sensor**  
Sense the brightness of the car interior.
- ② **- / + (DOWN/UP) button**  
Touch to adjust the volume.
- ③ **🔇 (MUTE) button**  
Touch to activate/deactivate the mute mode.
- ④ **🏠 (HOME)/(Power Off) button**  
Activates the HOME screen.  
Touch and hold this button for at least 2 seconds to turn the power off.
- ⑤ **🎤 button**  
Depending on the connected smartphone, touch to activate Siri function or voice recognition mode.
- ⑥ **📞 (Phone) button**  
When a Hands-Free Phone is not connected:  
The Bluetooth setting screen is displayed.  
When a Hands-Free Phone is connected:  
The phone number input screen (Keypad) is activated.  
Touch and hold the button for at least 2 seconds to redial the most recent incoming call.  
During an incoming call:  
The phone call is started.  
During a call:  
The call finishes.

## Turning Power On or Off

### 1 Turn the ignition key to the ACC or ON position.

The system is turned on.

### 2 Touch and hold the (HOME) button for at least 2 seconds to turn the power off.

- When the system is used for the first time, the language selection menu is displayed. Select the desired language, and then touch [OK].

## About the HOME Screen

Select a widget on the HOME screen to perform various settings and operations of the function.

### 1 Touch the (HOME) button.

The HOME screen is displayed.

#### ■ HOME screen example

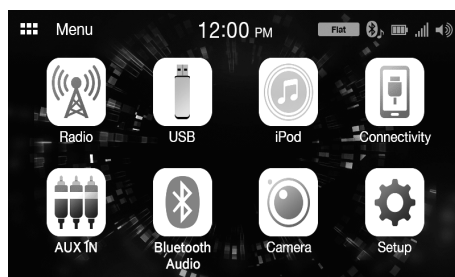

Radio	Displays the Radio main screen.
USB	You can play back music files (MP3/WMA/AAC/FLAC/WAV), video files (MP4/AVI/WMV/MOV) and photo files (JPG/PNG/BMP) stored in a USB flash drive. <ul style="list-style-type: none"><li>• If a USB flash drive is not connected, this widget is not available.</li></ul>
iPod	Displays the iPod main screen. <ul style="list-style-type: none"><li>• If an iPhone is not connected, this widget is not available.</li></ul>
Connectivity (Apple CarPlay)/ (Android Auto)	You can use Apple CarPlay or Android Auto. <ul style="list-style-type: none"><li>• If an iPhone 5s or later compatible with the Apple CarPlay function or a smartphone installed with the Android Auto App is not connected, this widget is not available.</li><li>• When Apple CarPlay or Android Auto is available, the widget changes to [Apple CarPlay] / [Android Auto].</li></ul>
Bluetooth Audio	Displays the Bluetooth audio main screen.
AUX IN	Display the Auxiliary (AUX) screen.
Camera	Displays camera images.
Setup	Displays the Setup screen.

## Apple CarPlay Operation (Optional)

Apple CarPlay is a smarter, safer way to use your iPhone in the car. Apple CarPlay takes the things you want to do with your iPhone while driving and puts them right on this unit. You can get directions, make calls, send and receive messages, and listen to music, all in a way that allows you to stay focused on the road. Just plug in your iPhone to this unit and go.

### 1 Touch the (HOME) button.

The HOME screen is displayed.

### 2 Touch [Apple CarPlay].

The Apple CarPlay screen is displayed.

- Refer to "Apple CarPlay" in the Owner's Manual for information on how to operate Apple CarPlay.

## Android Auto™ (Optional)

Android Auto is designed to make it easier to use apps from your phone while you're on the road. Navigate with Google Maps, listen to playlists or podcasts from your favorite apps, send messages via voice, and more. Download the Android Auto App from the Google Play store before continuing.

### 1 Touch the (HOME) button.

The HOME screen is displayed.

### 2 Touch [Android Auto].

The Android Auto screen is displayed.

- Refer to "Android Auto" in the Owner's Manual for information on how to operate Android Auto.



## Radio Operation

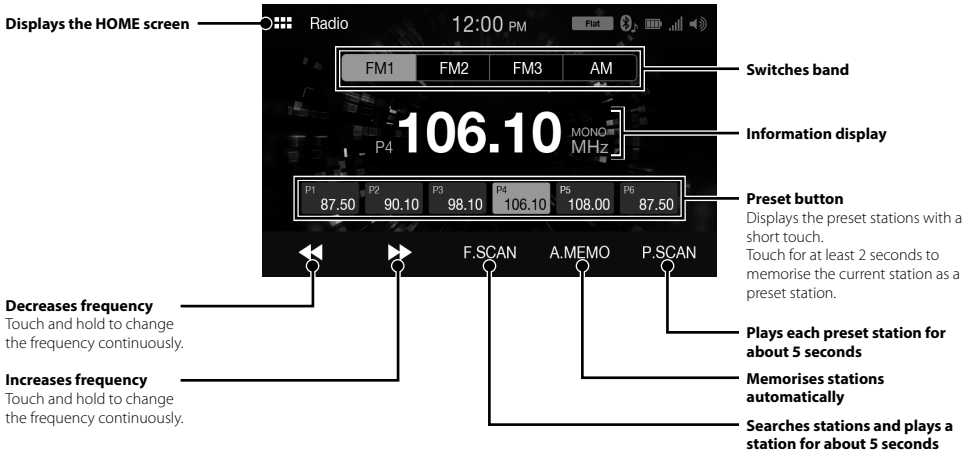

- The patterns of some keys in the Quick Reference Guide may differ from the actual screen.

## USB Flash drive Operation (Optional)

You can play back music files (MP3/WMA/AAC/FLAC/WAV) and video files (MP4/AVI/WMV/MOV) stored in a USB flash drive on the internal player of this system.

### USB Audio main screen example

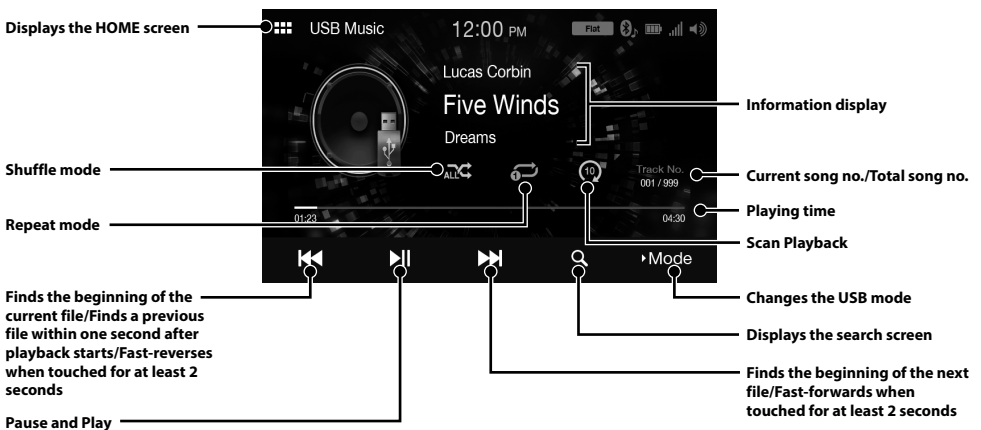

- The patterns of some keys in the Quick Reference Guide may differ from the actual screen.

## iPod mode on iPhone (Optional)

A separately sold Lightning to USB cable (KCU-471i) is required depending on the type of iPhone.



- This unit supports iPhone (iPhone 5s or later) only. For using music playback only, set the "Apple CarPlay" setting to "Off" before connecting with your iPhone.
- The patterns of some keys in the Quick Reference Guide may differ from the actual screen.

## Searching for a Music File

For example: Searching by Artist name

- 1 Touch [Q (Search)] during playback.
- 2 Touch [Artists].

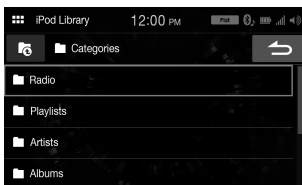

- 3 Touch the desired artist's name.

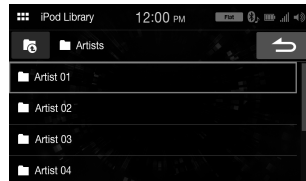

- 4 Touch the desired album's name.
- 5 Touch the desired song's name.

The selected song is played back.

## Hands-Free Phone Control

The unit can connect with up to two hands-free phones.

### How to connect to a Bluetooth compatible device (Pairing)

**1 Touch [Setup] on the HOME screen.**

**2 Touch [Bluetooth].**



**3 Touch [Search] to search for a new device.**

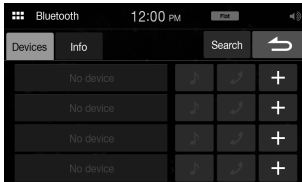

**4 Touch the device you want to connect from the list.**

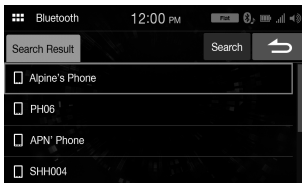

**5 The device registration is complete.**

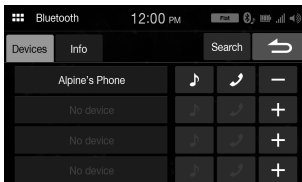

- You can register up to 4 Bluetooth compatible mobile phones.

- The Bluetooth registration process differs depending on the device version and SSP (Simple Secure Pairing). If a 4 or 6 character Passcode appears on this device, enter the Passcode using the Bluetooth compatible device. If a 6 character Passkey appears on this device, make sure the same passkey is displayed on the Bluetooth compatible device.

### Answering a Call

**1 An incoming call triggers the ringtone and an incoming call display.**

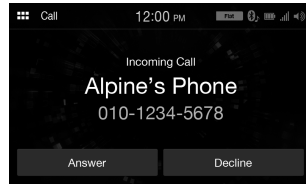

**2 Touch [Answer].**

The call starts.

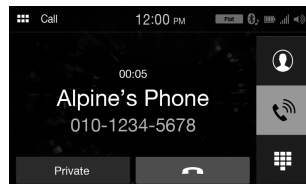

### Hanging up the Telephone

**1 Touch [End Call].**

The call finishes.

# Installation

## Note on installation

- Install at an angle between horizontal and 30°. Note that installing at an angle outside of this range will result in a loss of performance and possible damage.

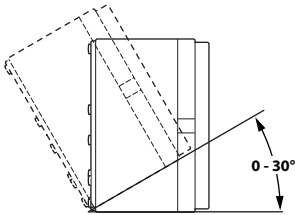

- Do not block the unit's heat sink, which would prevent air circulation. If blocked, heat will accumulate inside the unit and may cause a fire.

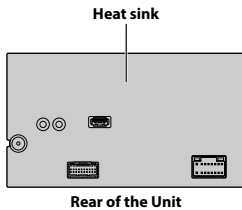

## Mounting the Microphone

For safe use, make sure of the following:

- Location is stable and firm.
- Driver's view and operations are not obstructed.
- Microphone is located where the driver's voice can be easily picked up (on the sun visor, etc.).

When you speak into the microphone, you should not have to change your driving posture. This may cause a distraction, taking your attention away from safely driving your vehicle. Carefully consider direction and distance while mounting the microphone. Confirm that the driver's voice can be easily picked up at the selected location.

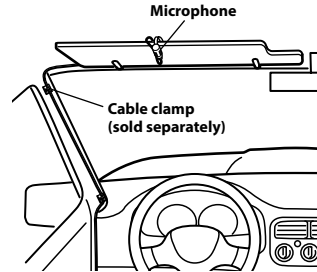

## Installing the Unit

- 1 Mount the original mounting bracket to the unit using the supplied screws.**

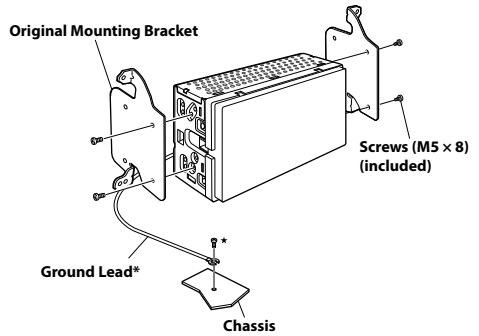

- 2 Connect all other leads of the unit according to details described in the "Connections" (page 12).**

- 3 Mounting the unit in a car.**

- \* To securely connect the ground lead, use an already installed screw on a metal part of the vehicle (marked ★) or a clean, bare metal spot on the vehicle's chassis.
- Fix the cables carefully. Do not damage them by tucking them into movable parts, such as a seat rail, or by locating them against sharp or pointed edges.

## Connection Diagram of SPST Switch (sold separately)

(If the ACC power supply is not available)

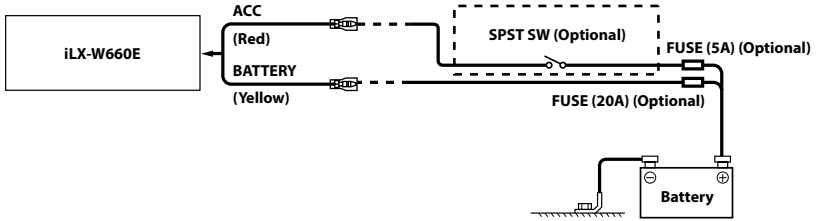

- If your vehicle has no ACC power supply, add an SPST (Single-Pole, Single-Throw) switch (sold separately) and fuse (sold separately).
- The diagram and the fuse amperage shown above are in the case when the unit is used individually.
- If the switched power (ignition) lead of the unit is connected directly to the positive (+) post of the vehicle's battery, the unit draws some current (several hundred milliamperes) even when its switch is placed in the OFF position, and the battery may be discharged.

# Connections

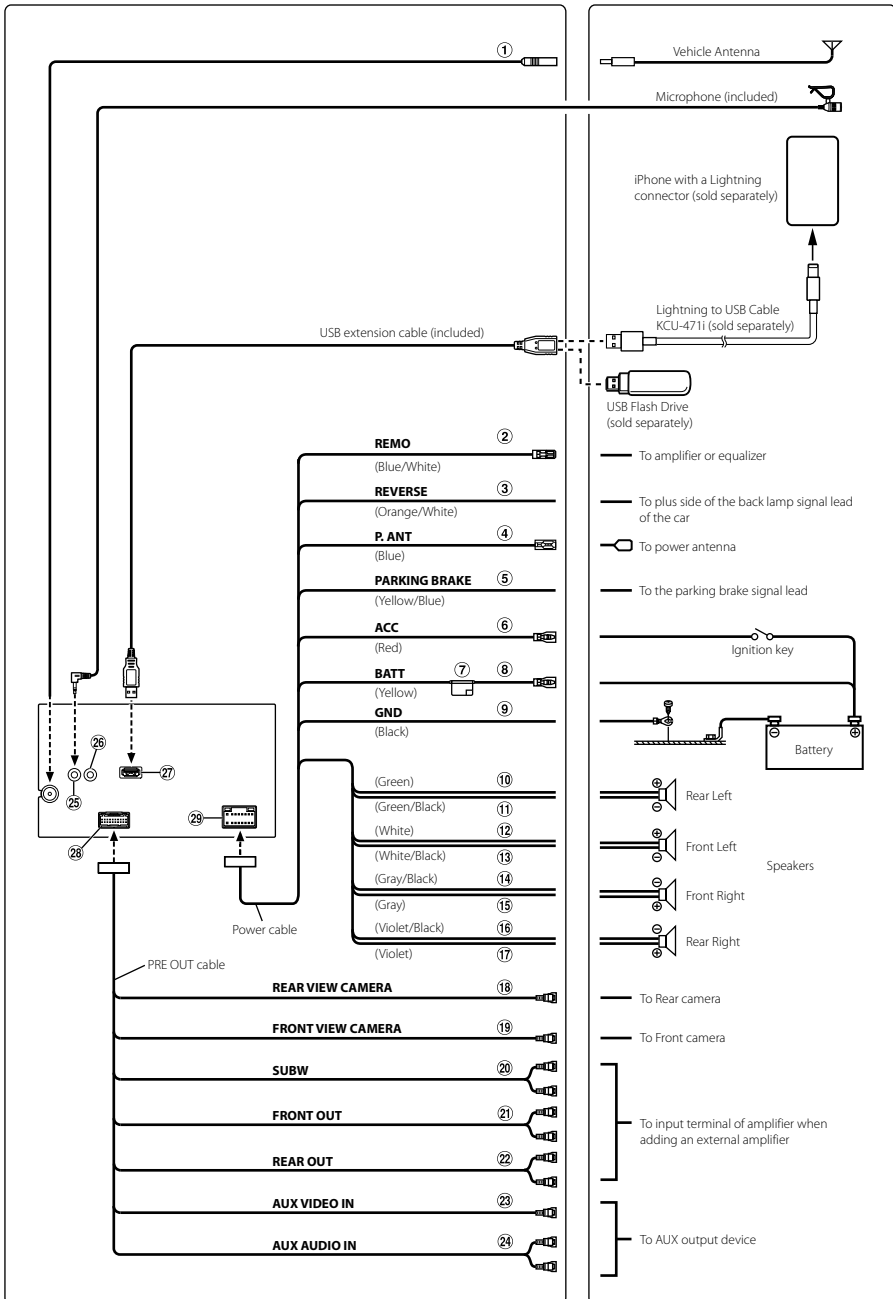

- ① **Radio Antenna Receptacle**
- ② **Remote Turn-On Lead (Blue/White)**  
Connect this lead to the remote turn-on lead of your amplifier or signal processor.
- ③ **Reverse Lead (Orange/White)**
- ④ **Power Antenna Lead (Blue)**  
Connect this lead to the +B terminal of your power antenna, if applicable.  
This lead should be used only for controlling the vehicle's power antenna. Do not use this lead to turn on an amplifier or a signal processor, etc.
- ⑤ **Parking Brake Lead (Yellow/Blue)**  
Connect this lead to the power supply side of parking brake switch to transmit the parking brake status signals to the unit.
- ⑥ **Switched Power Lead (Ignition) (Red)**  
Connect this lead to an open terminal on the vehicle's fuse box or another unused power source that provides (+) 12V only when the ignition is turned on or in the accessory position.
- ⑦ **Fuse Holder (15A)**
- ⑧ **Battery Lead (Yellow)**  
Connect this lead to the positive (+) post of the vehicle's battery.
- ⑨ **Ground Lead (Black)**  
Connect this lead to a good chassis ground on the vehicle.  
Make sure the connection is made to bare metal and is securely fastened using the sheet metal screw provided.
- ⑩ **Left Rear (+) Speaker Output Lead (Green)**
- ⑪ **Left Rear (-) Speaker Output Lead (Green/Black)**
- ⑫ **Left Front (+) Speaker Output Lead (White)**
- ⑬ **Left Front (-) Speaker Output Lead (White/Black)**
- ⑭ **Right Front (-) Speaker Output Lead (Gray/Black)**
- ⑮ **Right Front (+) Speaker Output Lead (Gray)**
- ⑯ **Right Rear (-) Speaker Output Lead (Violet/Black)**
- ⑰ **Right Rear (+) Speaker Output Lead (Violet)**
- ⑱ **REAR CAMERA Input RCA Connector**  
Use when connecting a rear camera with RCA Output Connector.
- ⑲ **FRONT CAMERA Input RCA Connector**  
Use when connecting a front camera with RCA Output Connector.
- ⑳ **Subwoofer RCA Connectors**
- ㉑ **Front Output RCA Connectors**  
Can be used as Front Output RCA Connectors. RED is right and WHITE is left.
- ㉒ **Rear Output RCA Connectors**  
Can be used as Rear Output RCA Connectors. RED is right and WHITE is left.
- ㉓ **AUX VIDEO IN RCA Connector**  
Use when connecting a AUX device with Video RCA Output Connector.
- ㉔ **AUX AUDIO IN RCA Connector**  
Use when connecting a AUX device with Video RCA Output Connector. Red is right and WHITE is left.
- ㉕ **MIC Input Connector**  
To Microphone (included)
- ㉖ **Steering Remote Control Interface Connector**  
To steering remote control interface.  
For details about connections, consult your nearest Alpine dealer.
- ㉗ **USB Connector**  
To USB flash drive, iPhone or Android smartphone.
- ㉘ **CAMERA/PRE OUT Connector**
- ㉙ **Power Supply Connector**

# Specifications

## MONITOR SECTION

Screen Size	7"
LCD Type	Transparent type TN LCD
Operation System	TFT active matrix
Number of Picture Elements	1,152,000 pcs. (800 × 480 × 3 (RGB))
Effective Number of Picture Elements	99% or more
Illumination System	LED

## FM TUNER SECTION

Tuning Range	87.5 – 108.0 MHz
Mono Usable Sensitivity	9.3 dBf (0.8 μV/75 ohms)
50 dB Quieting Sensitivity	13.5 dBf (1.3 μV/75 ohms)
Alternate Channel Selectivity	80 dB
Signal-to-Noise Ratio	65 dB
Stereo Separation	35 dB
Capture Ratio	2.0 dB

## AM TUNER SECTION

Tuning Range	531 – 1,602 kHz
Usable Sensitivity	25.1 μV/28 dBf

## USB SECTION

USB requirements	USB 2.0
Max. Power Consumption	1,000 mA (CDP Support)
USB Class	USB (Play From Device)/ USB (Mass Storage Class)
File System	FAT16/32
Number of Channels	2-Channels (Stereo)
Frequency Response*1	5 – 20,000 Hz (±1 dB)
Total Harmonic Distortion	0.008% (at 1 kHz)
Dynamic Range	95 dB (at 1 kHz)
Signal-to-Noise Ratio	100 dB
Channel Separation	85 dB (at 1 kHz)

\*1 Frequency response may differ depending on the encoder software/bit rate.

## Bluetooth SECTION

Bluetooth Specification	Bluetooth V4.2
Output Power	+4 dBm Ave. (Power class 2)
Profile	HFP (Hands-Free Profile) PBAP (Phone Book Access Profile) A2DP (Advanced Audio Distribution Profile) AVRCP (Audio/Video Remote Control Profile)

## GENERAL

Power Requirement	14.4 V DC (11–16 V allowable)
Operating temperature	-20°C to + 60°C
Power Output	45 W × 4
Weight	0.92 kg
Audio output level	
Preout (Front, Rear):	4V/10k ohms (max.)
Preout (Subwoofer):	4V/10k ohms (max.)

## CHASSIS SIZE

Width	178 mm
Height	100 mm
Depth	60 mm

- *Due to continuous product improvement, specifications and design are subject to change without notice.*
- *The LCD panel is manufactured using an extremely high precision manufacturing technology. Its effective pixel ratio is over 99.99%. This means that there is a possibility that 0.01% of the pixels could be either always ON or OFF.*



- Windows Media and the Windows logo are trademarks, or registered trademarks of Microsoft Corporation in the United States and/or other countries.
- Apple, iPhone, and Siri are trademarks of Apple Inc., registered in the U.S. and other countries. Apple CarPlay is a trademark of Apple Inc.
- Use of the Made for Apple and Works with Apple badges means that an accessory has been designed to connect specifically to the Apple product(s) identified in the Made for Apple badge and to work specifically with the technology identified in the Works with Apple badge, and has been certified by the developer to meet Apple performance standards. Apple is not responsible for the operation of this device or its compliance with safety and regulatory standards.
- Please note that the use of this accessory with an Apple product may affect wireless performance.
- Use of the Apple CarPlay logo means that a vehicle user interface meets Apple performance standards. Apple is not responsible for the operation of this vehicle or its compliance with safety and regulatory standards. Please note that the use of this product with iPhone may affect wireless performance.
- Google, Android, Android Auto, Google Play and other marks are trademarks of Google LLC.
- The Bluetooth® word mark and logos are registered trademarks owned by the Bluetooth SIG, Inc. and any use of such marks by ALPS ALPINE CO., LTD. is under license.
- MPEG Layer-3 audio coding technology licensed from Fraunhofer IIS and Thomson. Supply of this product only conveys a license for private, non-commercial use and does not convey a license nor imply any right to use this product in any commercial (i.e. revenue-generation) real time broadcasting (terrestrial, satellite, cable and/or any other media), broadcasting/streaming via internet, intranets and/or other networks or in other electronic content distribution systems, such as pay-audio or audio-on-demand applications. An independent license for such use is required. For details, please visit <http://www.mp3licensing.com>



**ALPINE ELECTRONICS MARKETING, INC.**

1-7, Yukigaya-Otsukamachi, Ota-ku,  
Tokyo 145-0067, JAPAN  
Phone: 03-5499-4531

**ALPINE ELECTRONICS OF AMERICA, INC.**

1500 Atlantic Blvd,  
Auburn Hills, Michigan 48326, U.S.A.  
Phone 1-800-ALPINE-1 (1-800-257-4631)

**ALPINE ELECTRONICS OF AUSTRALIA PTY. LIMITED**

161-165 Princes Highway,  
Hallam Victoria 3803, Australia  
Phone 03-8787-1200

**ALPINE ELECTRONICS GmbH**

Ohmstraße 4  
85716 Unterschleißheim, Germany  
Phone: 089-32 42 640

**ALPINE ELECTRONICS OF U.K., LTD.**

Alpine House Fletchamstead Highway,  
Coventry CV4 9TW, U.K.  
[www.alpine.co.uk](http://www.alpine.co.uk)

**ALPINE ELECTRONICS GmbH Succursale France**

184 allée des Erables  
CS 52016 – Villepinte  
95 945 Roissy CDG cedex  
FRANCE  
Phone : + 33(0)1 48 63 89 89

**ALPINE ITALIA S.p.A.**

Viale Cristoforo Colombo, 8  
20090 Trezzano sul Naviglio MI, Italy  
Phone +39 02 484781

**ALPINE ELECTRONICS GmbH Sucursal en España**

Portal de Gamarra 36, Pabellón, 32  
01013 Vitoria (Alava)-APDO 133, Spain  
Phone 945-283588