



9-inch Digital Media Station iLX-F259E



androidauto™



- OWNER'S MANUAL
Please read before using this equipment.

ALPINE ELECTRONICS MARKETING, INC.

1-7, Yukigaya-Otsukamachi, Ota-ku,
Tokyo 145-0067, JAPAN
Phone: 03-5499-4531

ALPINE ELECTRONICS OF AMERICA, INC.

1500 Atlantic Blvd,
Auburn Hills, Michigan 48326 U.S.A.
Phone 1-800-ALPINE-1 (1-800-257-4631)

ALPINE ELECTRONICS OF AUSTRALIA PTY. LIMITED

161-165 Princes Highway, Hallam
Victoria 3803, Australia
Phone 03-8787-1200

ALPINE ELECTRONICS GmbH

Ohmstraße 4
85716 Unterschleißheim, Germany
Phone: 089-32 42 640

ALPINE ELECTRONICS OF U.K., LTD.

Alpine House
Fletchamstead Highway, Coventry CV4 9TW, U.K.
www.alpine.co.uk

ALPINE ELECTRONICS FRANCE S.A.R.L.

184 allée des Erables
CS 52016 – Villepinte
95 945 Roissy CDG cedex
FRANCE
Phone : + 33(0)1 48 63 89 89

ALPINE ITALIA S.p.A.

Viale Cristoforo Colombo 8,
20090 Trezzano sul Naviglio MI, Italy
Phone +39 02 484781

ALPINE ELECTRONICS DE ESPAÑA, S.A.

Portal de Gamarra 36, Pabellón, 32
01013 Vitoria (Alava)-APDO 133, Spain
Phone 945-283588

Contents

Operating Instructions

WARNING

Points to Observe for Safe Usage	5
WARNING	5
CAUTION	6
NOTICE	6

Getting Started

Location of Controls	8
Turning Power On or Off	8
Initial System Start-Up	8
Adjusting the Volume	8
Lowering Volume Quickly	9
Touch Screen Operation	9
Switching Sources	9
Selecting an Item in a List	9
About the HOME Screen	10
Editing HOME screen	10
About the Indicator Display	10

Setup

Setup Operation	11
-----------------------	----

General Setup

Radio Setup	11
Setting the TUNER (FM) Tone Quality (Tuner Condition)	11
Language Setup	12
Wallpaper Setup	12
Setting a Wallpaper using a default image	12
Setting a Wallpaper using your image	12
Screen/LED Customize Setup	12
Setting the Brightness of the Backlighting (Dimmer)	12
Adjusting the Minimum Level of Backlight	12
Adjusting the Dimmer of Button Lighting at Night	13

Clock Setup	13
Display Off Setting	13
About iLX-F259	13
Displaying the Product Information	13
Displaying Warranty/Copyright Information	13
Initializing the System	13
Installation Setup	14

Connection (Bluetooth) Setup

Displaying Bluetooth Information	14
Pairing the Bluetooth Device	14
Setting the Bluetooth Device	15
Deleting a Bluetooth Device from the list	15
Auto Answering Setup	15
Apple CarPlay Setup	15

Camera Setup

Camera Input Setting	15
Camera Signal Input Setting	15
Rear Camera Guide Settings	16
Turning the Rear Camera Guide On/Off	16
Adjusting the Caution Position	16
Camera Picture Quality Setup	16
Camera Interrupt Setting (DISPLAY OFF Mode)	16
Mute Setting	16

Sound Setup

Setting the Media Xpander (MX)	17
Equalizer Settings	17
Fader/Balance/Bass/Treble/Subwoofer Settings	17
Setting the Fader/Balance	17
Adjusting the Bass/Treble	18
Setting the Subwoofer	18
Graphic Equalizer Curve Settings (Graphic EQ)	18
Time Correction Settings	18
Crossover Settings (X-Over)	19
Volume Setup	19
Adjusting the Key Sound	19
Adjusting the Source Volume	19
Setting the Volume for Android Auto	19

Setting the Volume for Apple CarPlay	20
Adjusting the Volume for Phone	20
Turning Subwoofer ON/OFF	20
Rear Speaker Setting	20
Defeat Setting	20
About the Crossover	20
About Time Correction	21

Apple CarPlay (Optional)

Access to Apple CarPlay	22
-------------------------------	----

Android Auto (Optional)

What is Android Auto	22
Activate Android Auto	22

Radio

Radio Basic Operation

Listening to the Radio	23
Presetting Stations Manually	23
Presetting Stations Automatically	23
Tuning to Preset Station	23

USB Flash drive (Optional)

USB Audio

Playback	24
Fast-forwarding/Fast-reversing	24
Repeat Play	24
Shuffle Play	25
Searching for a Desired Song	25

USB Video

Setting the Brightness and Contrast	25
Displaying the Subtitle	25

USB Photo

Playback	26
Slide Show	26
Setting a Wallpaper with a Photo	26

iPod mode on iPhone (Optional)

Playback	27
Searching for a Music File	28
Repeat Play	28
Shuffle Play	28

Bluetooth Operation

Setup Before Using	29
About Bluetooth	29
About the Hands-free Phone	29
Before Using Bluetooth	29

Hands-free Phone Control

Answering a Call	30
Hanging up the Telephone	30
Calling	30
Making a phone call using the Phone Menu	30
Using Voice Recognition function	31
Using Siri	31
Voice Dial Function	31
Phone Operation Screen	32
Adjusting the Speech Volume	32
Changing the Voice Output	32
Muting the Microphone	32
DTMF (Touch-Tone) Function	32
Phone Book Function	32
Searching in the Phone Book	32
Synchronizing the Phone Book	32
Deleting the Phone Book Entries	33
Setting contacts as Favorites (Shortcut Dialing)	33

Bluetooth Audio

Playback	34
Repeat Play	34
Shuffle Play	34
Connecting a Bluetooth Device	34
Disconnecting the Bluetooth Connection ...	34
Switching the connecting Bluetooth Device	34

Camera Operation (Optional)

Camera Operation	35
Displaying the Camera Image from the HOME screen	35
Displaying the rear view video while the car is in reverse	35
About the Rear Camera Guide	35

Information

Product Software Update	37
About the Supported Formats	37
About MP3/WMA/AAC/FLAC/WAV	37

In Case of Difficulty	39
If this Message Appears	40
Specifications	41

Operating Instructions

WARNING

Points to Observe for Safe Usage

- Read this manual carefully before using this disc and the system components. They contain instructions on how to use this product in a safe and effective manner. Alpine cannot be responsible for problems resulting from failure to observe the instructions in this manual.
- This manual uses various pictorial displays to show you how to use this product safely and to alert you to potential dangers resulting from improper connections and operation. Following are the meanings of these pictorial displays. It is important to fully understand the meanings of these pictorial displays in order to use this manual and the system properly.



WARNING

- Operation of the system while driving is dangerous. Users should stop vehicle before operating the software.
- Road conditions and regulations take precedence over information contained on the map display: observe actual traffic restrictions and circumstances while driving.
- This software is designed for use exclusively in the unit. It cannot and may not be used in conjunction with other hardware.



WARNING

This symbol means important instructions. Failure to heed them can result in serious injury or death.

INSTALL THE PRODUCT CORRECTLY SO THAT THE DRIVER CANNOT WATCH TV/VIDEO UNLESS THE VEHICLE IS STOPPED AND THE EMERGENCY BRAKE IS APPLIED.

It is dangerous for the driver to watch TV/Video while driving a vehicle. Installing this product incorrectly enables the driver to watch TV/Video while driving. This may cause a distraction, preventing the driver from looking ahead, thus causing an accident. The driver or other people could be severely injured.

DO NOT WATCH VIDEO WHILE DRIVING.

Watching the video may distract the driver from looking ahead of the vehicle and cause an accident.

DO NOT OPERATE ANY FUNCTION THAT TAKES YOUR ATTENTION AWAY FROM SAFELY DRIVING YOUR VEHICLE.

Any function that requires your prolonged attention should only be performed after coming to a complete stop. Always stop the vehicle in a safe location before performing these functions. Failure to do so may result in an accident.

KEEP THE VOLUME AT A LEVEL WHERE YOU CAN STILL HEAR OUTSIDE NOISES WHILE DRIVING.

Excessive volume levels that obscure sounds such as emergency vehicle sirens or road warning signals (train crossings, etc.) can be dangerous and may result in an accident. LISTENING AT LOUD VOLUME LEVELS IN A CAR MAY ALSO CAUSE HEARING DAMAGE.

MINIMIZE DISPLAY VIEWING WHILE DRIVING.

Viewing the display may distract the driver from looking ahead of the vehicle and cause an accident.

DO NOT DISASSEMBLE OR ALTER.

Doing so may result in an accident, fire or electric shock.

USE ONLY IN CARS WITH A 12 VOLT NEGATIVE GROUND.

(Check with your dealer if you are not sure.) Failure to do so may result in fire, etc.

KEEP SMALL OBJECTS SUCH AS SCREWS OUT OF THE REACH OF CHILDREN.

Swallowing them may result in serious injury. If swallowed, consult a physician immediately.

USE THE CORRECT AMPERE RATING WHEN REPLACING FUSES.

Failure to do so may result in fire or electric shock.

DO NOT BLOCK VENTS OR RADIATOR PANELS.

Doing so may cause heat to build up inside and may result in fire.

USE THIS PRODUCT FOR MOBILE 12V APPLICATIONS.

Use for other than its designed application may result in fire, electric shock or other injury.

MAKE THE CORRECT CONNECTIONS.

Failure to make the proper connections may result in fire or product damage.

BEFORE WIRING, DISCONNECT THE CABLE FROM THE NEGATIVE BATTERY TERMINAL.

Failure to do so may result in electric shock or injury due to electrical shorts.

DO NOT ALLOW CABLES TO BECOME ENTANGLED IN SURROUNDING OBJECTS.

Arrange wiring and cables in compliance with the manual to prevent obstructions when driving. Cables or wiring that obstruct or hang up on places such as the steering wheel, gear lever, brake pedals, etc. can be extremely hazardous.

DO NOT SPLICE INTO ELECTRICAL CABLES.

Never cut away cable insulation to supply power to other equipment. Doing so will exceed the current carrying capacity of the wire and result in fire or electric shock.

DO NOT DAMAGE PIPE OR WIRING WHEN DRILLING HOLES.

When drilling holes in the chassis for installation, take precautions so as not to contact, damage or obstruct pipes, fuel lines, tanks or electrical wiring. Failure to take such precautions may result in fire.

DO NOT USE BOLTS OR NUTS IN THE BRAKE OR STEERING SYSTEMS TO MAKE GROUND CONNECTIONS.

Bolts or nuts used for the brake or steering systems (or any other safety-related system), or tanks should NEVER be used for installations or ground connections. Using such parts could disable control of the vehicle and cause fire etc.

DO NOT INSTALL IN LOCATIONS WHICH MIGHT HINDER VEHICLE OPERATION, SUCH AS THE STEERING WHEEL OR SHIFT LEVER.

Doing so may obstruct forward vision or hamper movement etc. and results in serious accident.

 CAUTION
This symbol means important instructions. Failure to heed them can result in injury or material property damage.

HALT USE IMMEDIATELY IF A PROBLEM APPEARS.

Failure to do so may cause personal injury or damage to the product. Return it to your authorized Alpine dealer or the nearest Alpine Service Center for repairing.

HAVE THE WIRING AND INSTALLATION DONE BY EXPERTS.

The wiring and installation of this unit requires special technical skill and experience. To ensure safety, always contact the dealer where you purchased this product to have the work done.

USE SPECIFIED ACCESSORY PARTS AND INSTALL THEM SECURELY.

Be sure to use only the specified accessory parts. Use of other than designated parts may damage this unit internally or may not securely install the unit in place. This may cause parts to become loose resulting in hazards or product failure.

ARRANGE THE WIRING SO IT IS NOT CRIMPED OR PINCHED BY A SHARP METAL EDGE.

Route the cables and wiring away from moving parts (like the seat rails) or sharp or pointed edges. This will prevent crimping and damage to the wiring. If wiring passes through a hole in metal, use a rubber grommet to prevent the wire's insulation from being cut by the metal edge of the hole.

DO NOT INSTALL IN LOCATIONS WITH HIGH MOISTURE OR DUST.

Avoid installing the unit in locations with high incidence of moisture or dust. Moisture or dust that penetrates into this unit may result in product failure.

 **NOTICE**

Product Cleaning

Use a soft dry cloth for periodic cleaning of the product. For more severe stains, please dampen the cloth with water only. Anything else has the chance of dissolving the paint or damaging the plastic.

Temperature

Be sure the temperature inside the vehicle is between +45°C (+113°F) and 0°C (+32°F) before turning your unit on.

Maintenance

If you have problems, do not attempt to repair the unit yourself. Return it to your Alpine dealer or the nearest Alpine Service Station for servicing.

Protecting the USB connector

- Only an iPhone or USB flash drive can be connected to the USB connector on this unit. Correct performance using other USB products cannot be guaranteed.
- If the USB connector is used, be sure to use only the supplied connector cable with the unit. A USB hub is not supported.
- Depending on the connected USB flash drive, the unit may not function or some functions may not be performed.
- The audio file format that can be played back on the unit is MP3/WMA/AAC/FLAC/WAV.
- Artist/song name, etc., can be displayed. Certain, special characters may not be correctly displayed.



CAUTION

Alpine accepts no responsibility for lost data, etc., even if data, etc., is lost while using this product.

On Handling USB Flash drive

- This unit can control a memory storage device that supports the USB Mass Storage Class (MSC) protocol. Playable audio file formats are MP3, WMA, AAC, FLAC and WAV.
 - USB Flash drive function is not guaranteed. Use USB flash drive according to the terms of agreement. Read the USB flash drive Owner's Manual thoroughly.
 - Avoid usage or storage in the following locations:
 - Anywhere in the car exposed to direct sunlight or high temperatures.
 - Anywhere the possibility of high humidity or corrosive substances are present.
 - Fix the USB flash drive in a location where driver operation will not be hindered.
 - USB Flash drive may not function correctly at high or low temperature.
 - Use only certified USB flash drive. Note that even certified USB flash drive, may not function correctly depending on its type or state.
 - Depending on the settings of the USB flash drive type, memory state or encoding software, the unit may not play back or display properly.
 - USB Flash drive may take time to start playback. If there is a particular file other than audio in the USB flash drive, it may take considerable time before the file is played back or searched.
 - The unit can play back "mp3," "wma" or "m4a" file extensions.
 - Do not add the above extensions to a file other than audio data. This non-audio data will not be recognized. The resulting playback may contain noise that can damage speakers and/or amplifiers.
 - It is recommended to back up important data on a personal computer.
 - Do not remove the USB device while playback is in progress. Change SOURCE to something other than USB, then remove the USB device to prevent possible damage to its memory.
- Windows Media and the Windows logo are trademarks, or registered trademarks of Microsoft Corporation in the United States and/or other countries.
 - Apple, iPhone, and Siri are trademarks of Apple Inc., registered in the U.S. and other countries. Apple CarPlay is a trademark of Apple Inc.
 - Use of the Made for Apple and Works with Apple badges means that an accessory has been designed to connect specifically to the Apple product(s) identified in the Made for Apple badge and to work specifically with the technology identified in the Works with Apple badge, and has been certified by the developer to meet Apple performance standards. Apple is not responsible for the operation of this device or its compliance with safety and regulatory standards.
 - Please note that the use of this accessory with an Apple product may affect wireless performance.
 - Use of the Apple CarPlay logo means that a vehicle user interface meets Apple performance standards. Apple is not responsible for the operation of this vehicle or its compliance with safety and regulatory standards. Please note that the use of this product with iPhone may affect wireless performance.
 - Google, Android, Android Auto, Google Play and other marks are trademarks of Google LLC.
 - The Bluetooth® word mark and logos are registered trademarks owned by the Bluetooth SIG, Inc. and any use of such marks by Alpine Electronics, Inc. is under license.
 - MPEG Layer-3 audio coding technology licensed from Fraunhofer IIS and Thomson. Supply of this product only conveys a license for private, non-commercial use and does not convey a license nor imply any right to use this product in any commercial (i.e. revenue-generation) real time broadcasting (terrestrial, satellite, cable and/or any other media), broadcasting/streaming via internet, intranets and/or other networks or in other electronic content distribution systems, such as pay-audio or audio-on-demand applications. An independent license for such use is required. For details, please visit <http://www.mp3licensing.com>

Getting Started

Location of Controls

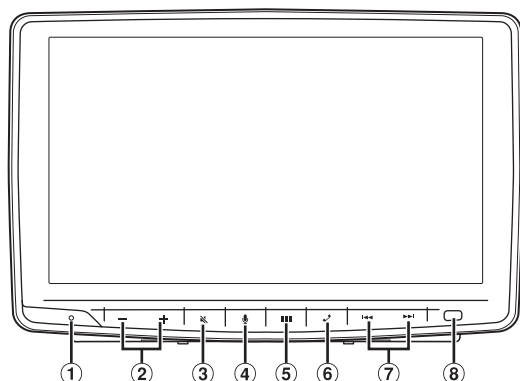

- ① **RESET switch**
The system will be reset.
- ② **- / + (DOWN/UP) button**
Adjusts the volume.
- ③ **[MUTE] button**
Activates/deactivates MUTE mode.
- ④ **[MICROPHONE] button**
Activate Siri function or voice recognition mode.
- ⑤ **[HOME] button**
Displays the HOME screen.
- ⑥ **[PHONE] button**
Displays the Phone Menu screen.
Touch to start a conversation when a call is incoming.
- ⑦ **[SEEK] button**
Seeks down/up stations in radio mode or down/up a track, chapter, etc., in other audio/visual sources.
- ⑧ **Dimmer Sensor**
Senses the brightness of the car interior.

About the button descriptions used in this Owner's Manual

The buttons found on the face of the unit are expressed in bold (e.g. **[HOME]**). The buttons found on the touch-screen display are shown in bold within brackets, [] (e.g. **[OK]**).

Turning Power On or Off

When the ignition key is turned to ACC or ON, the opening screen will be automatically displayed.

1 Turn the ignition key to the ACC or ON position.

The unit turns on.

- When the unit is used for the first time, the Radio main screen is displayed.
- When turned on, the unit displays the last screen that was displayed before the ignition key was turned off. For example, if the unit is in radio mode when ignition is turned off, it will remain in radio mode when ignition is turned back on.

2 To turn the unit to off, turn the ignition key to the OFF position.

- The unit is a precision device. Careful handling of the unit should provide you with years of trouble-free operation.
- Some of this unit's functions cannot be performed while the vehicle is in motion. Be sure to stop your vehicle in a safe location and apply the parking brake before attempting these operations.

Initial System Start-Up

Be sure to press the RESET switch when using the unit for the first time, after changing the car battery, etc.

1 Turn off the unit power.

2 Press the RESET switch with a ballpoint pen or similar pointed object.

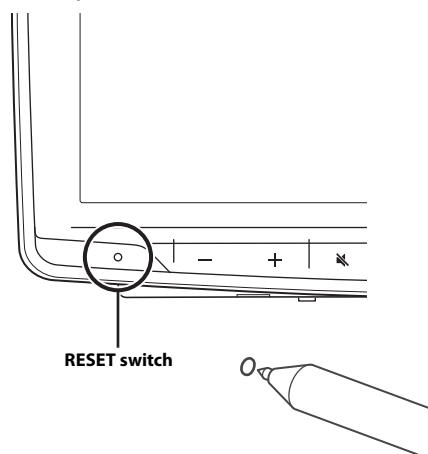

Adjusting the Volume



Adjust the volume by touching - / +.

Volume decreases/increases continuously by touching and holding - / +.

Volume: 0 to 35

Lowering Volume Quickly

Audio Mute function instantly lowers the volume level to 0.

- 1 Touch the  (MUTE) button to activate MUTE mode. The audio level will be 0.
- 2 Touch the  (MUTE) button again to bring the audio back to previous volume level.

Touch Screen Operation

You can operate the unit by using the touch panel display.

- Be sure to touch the onscreen button lightly with the pad of your finger to avoid scratching the display.

Touch operation

Touch a button or list item on the screen lightly.



- If you touch a button and there is no reaction, remove your finger.
- Onscreen buttons that cannot be operated are dimmed.

Swipe operation

Move your finger lightly with a swipe.

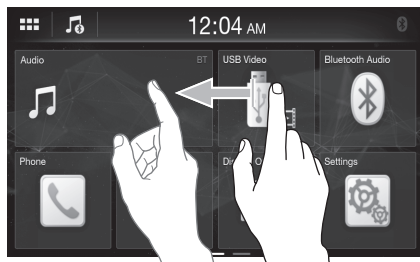

Drag & Drop operation

Touch and hold the desired item, then drag it to its new location by moving your finger, then release your finger to place the item.



- Except for USB Photo mode, it is not possible to narrow the screen with two fingers (pinch in) or spread the screen (pinch out).

Switching Sources

- 1 Touch the  (HOME) button. The HOME screen is displayed.



- 2 Touch a widget of your desired source.

- In the HOME screen, you can change the widget location on the screen. For details, see "About the HOME Screen" (page 10).

Selecting an Item in a List

To scroll through a list, perform the following operations.

Touch the screen and slide your finger up and down. The screen will scroll along with your finger movement.

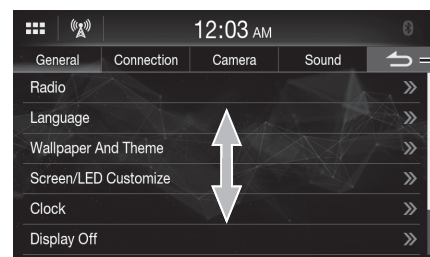

Returns to the previous screen. Depending on the function, this button may cancel the operations performed on the screen.

- After touching the screen, move your finger away from the screen before dragging and that item will be selected.

About the HOME Screen

In the HOME screen, select a widget to perform various settings and operations of the function.

Touch the (HOME) button.

The HOME screen is displayed.

- You can also display the HOME screen by touching [] at the top of the screen.

HOME screen example



HOME screen navigation

Swipe the HOME screen horizontally with your finger to change the page. Up to 3 pages exist.

- After selecting [Audio] widget, it is possible to switch the mode to USB Audio mode, iPod mode for iPhone or Bluetooth Audio mode.

Editing HOME screen

You cannot operate the Widgets editing screen while driving.

Your vehicle must be parked with the ignition key in the ACC or ON position. For details, see "To display the Setup Menu screen" in "Setup Operation" (page 11).

In the Widgets editing screen, you can change the audio source order or set the display/hidden settings.

1 Touch and hold the HOME screen for at least a second.

The widgets editing screen is displayed.

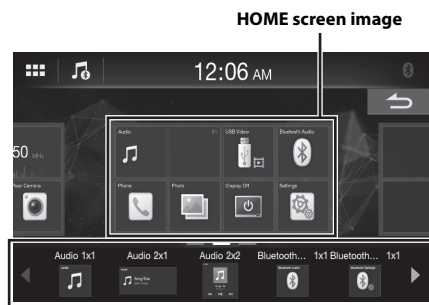

- The source icon displayed in the Widgets editing screen is displayed only when usable setup and conditions of each Audio source are fulfilled. For details on setup and conditions of each audio source, see "Switching Sources" (page 9).

Adding a widget

Drag and drop a widget from the additional candidate widgets area to the desired position of the HOME screen image area.

- To show more candidate widgets, swipe horizontally.
- There are 3 sizes of widgets.

Changing the order of widget

Drag and drop the widget to the desired location.

Deleting a widget from the HOME screen

Drag and drop a widget from the HOME screen image area to .

-  is displayed while touching a widget.

2 Touch the (HOME) button.

The HOME screen is displayed.

About the Indicator Display

The Indicator Bar at the top of the screen displays various types of information, like the current time.



- 1 Recalls the HOME screen.
- 2 Displays the currently playing audio source. Touch to return to the Audio source screen.
- 3 Indicates the current time.
You can switch between the 12 hour display and 24 hour display options (page 13).
- 4 Lights up when connected to a Bluetooth compatible device. (Does not display when connection is set to OFF.)

Setup

Setup Operation

- 1 Touch the  (HOME) button.
The HOME screen is displayed.



- 2 Touch [Settings].
The Settings menu screen is displayed.

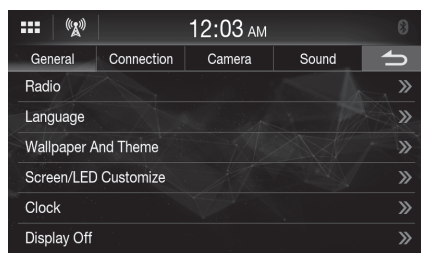

- 3 Touch the required setting genre on the upper part of the Settings menu screen, and then touch the setting item.

Setting genres:

General: See "General Setup" (page 11).
Connection: See "Connection (Bluetooth) Setup" (page 14).
Camera: See "Camera Setup" (page 15).
Sound: See "Sound Setup" (page 17).

General Setup

[General] is selected on the Settings menu screen.

General Setup Menu screen

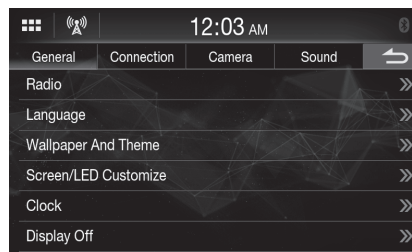

Setting items:

Radio (page 11)
Language (page 12)
Wallpaper And Theme (page 12)
Screen/LED Customize (page 12)
Clock (page 13)
Display Off (page 13)
About (page 13)
Installation (page 14)

Radio Setup

[Radio] is selected on the General Setup Menu screen.

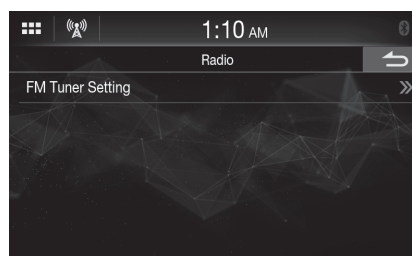

Setting the TUNER (FM) Tone Quality (Tuner Condition)

This unit can set your preferred tone quality for FM radio source.

Setting item:

FM Tuner Setting

Setting contents:

Normal (Initial setting) / HiFi / Stable

Normal: Standard setting
HiFi: High-quality setting
Stable: Control noise

- Noise may be more noticeable when [HiFi] is set, depending on the reception status. In this case, the [Normal] setting is recommended.

Language Setup

[Language] is selected on the General Setup Menu screen. The Setup menu, feedback information, etc. for this unit can be changed to appear in the selected language.

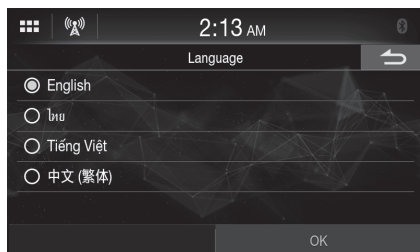

Setting item:

Language

Setting contents:

English, Thai, Vietnamese, Chinese

- The currently selected language is displayed.

Wallpaper Setup

[Wallpaper And Theme] is selected on the General Setup Menu screen. You can change the wallpaper of the display screen from 4 different colored default images or your image.



Setting a Wallpaper using a default image

Setting contents:

Amber / Blue / Green / Red

Touch the desired image, and then touch [Set Wallpaper].

Setting a Wallpaper using your image

1 Touch [User Image].

The image selecting screen is displayed.

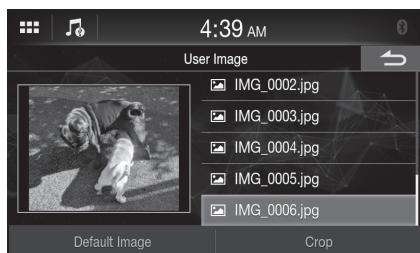

2 Select an image stored on the connected USB Flash drive.

The selected image thumbnail is displayed.

If not using an image as a wallpaper, touch [Default Image] to return to the previous screen without selecting.

3 Touch [Crop].

4 Touch the area to be trimmed for a wallpaper.

If the image is 800 × 480 pixel, this step is not necessary.

5 Touch [Set Theme] to change the theme color.

6 Touch the desired color.

7 Touch [Set Wallpaper].

Screen/LED Customize Setup

[Screen/LED Customize] is selected on the General Setup Menu screen.

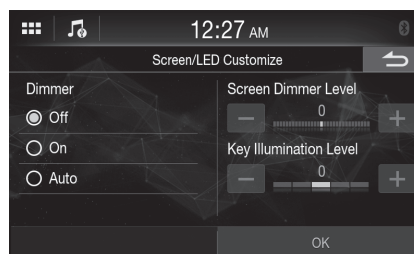

Setting item:

Dimmer / Screen Dimmer Level / Key Illumination Level

Setting the Brightness of the Backlighting (Dimmer)

Backlighting is provided by LEDs light built into the liquid crystal panel. The illumination control adjusts the brightness of the backlighting based on the car ambient lighting for easier viewing.

Setting item:

Dimmer

Setting contents:

Off (Initial setting), On, Auto

Off: Deactivate Auto Dimmer mode to keep the background illumination of the monitor bright.

On: Keep the background illumination of the monitor dark.

Auto: Adjust the brightness of the background illumination of the monitor automatically to the brightness of the car interior.

- When [On] is set, the setting is also applied for the button lighting in "Adjusting the Dimmer of Button Lighting at Night" (page 13) and "Adjusting the Minimum Level of Backlight" (page 12).

Adjusting the Minimum Level of Backlight

You can adjust the brightness of the backlight. This function could be used, for instance, to change the screen brightness while traveling at night.

Setting item:

Screen Dimmer Level

Setting contents:

-15 to 15 (Initial setting: 0)

- This setting is only available when "Dimmer" is set to [On] or [Auto].

Adjusting the Dimmer of Button Lighting at Night

You can adjust the brightness of the button lighting at night with the dimmer.

Setting item:

Key Illumination Level

Setting level:

-2 to 2 (Initial setting: 0)

- This setting is only available when “Dimmer” is set to [On] or [Auto].

Clock Setup

[Clock] is selected on the General Setup Menu screen.

You can set the current time and the clock display type, 12-hour or 24-hour, depending on your preference.

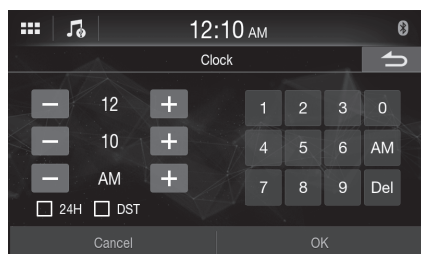

Setting item:

Clock

Touch [+] or [-] to adjust the hour, minute and AM/PM.

You can also use the number keys.

* To change to 24-hour, set “24H” to [On] (☑).

* To set the daylight saving time (Summer Time mode), set “DST” to [On] (☑).

Display Off Setting

When [Display Off] is selected on the General Setup Menu screen, the display is turned Off.

Setting item:

Display Off

- To cancel Display Off mode, touch the screen or any button.
- Display Off mode is canceled when the power or ACC is turned off.
- When the gear lever is shifted to the reverse (R) position and the rear camera is connected, the rear camera image is displayed.
- When a call is received on a Bluetooth-connected phone, the incoming call screen is displayed.
- You can also activate Display Off mode directly by touching the [Display Off] widget on the HOME screen.

About iLX-F259

[About] is selected on the General Setup Menu screen.

[About] enables you to check the Serial No., Firmware Version, Model Name, and to initialize various settings.

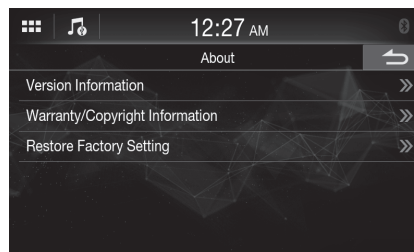

Displaying the Product Information

You can view the version information of this product. Make note of this information and refer to it whenever you contact Alpine Tech Support or an Alpine-authorized dealer.

Setting item:

Version Information

Setting contents:

Serial No. / SYSTEM version / Firmware Version

Displaying Warranty/Copyright Information

Setting item:

Warranty/Copyright Information

Setting contents:

Open source licenses / Notice

Initializing the System

You can initialize all data, to restore the factory settings. Remove the USB flash drive, etc. from the system before operation

- 1 Touch [Restore Factory Setting].**
- 2 After the confirmation message appears, touch [Yes].**
The system starts initialization.
The confirmation screen appears.
- 3 Touch [Confirm].**
 - Do not turn on/off the power, change the ignition key position or remove the screen panel until system restart is completed.

Installation Setup

[Installation] is selected on the General Setup Menu screen. Vehicle Setup enables you to check the connection status of Reverse Lead/Parking Brake Lead.

When selecting the item, the Installation check screen is displayed.

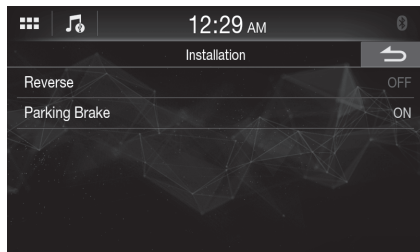

Setting item:

Installation

Setting contents:

Reverse / Parking Brake

Connection (Bluetooth) Setup

[Connection] is selected on the Setup menu screen.

■ **Connection Setup Menu screen**

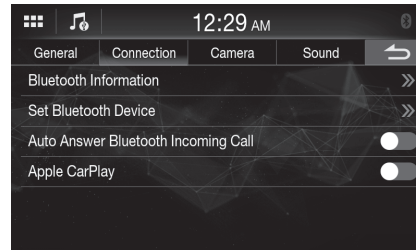

Setting items:

Bluetooth Information (page 14)

Set Bluetooth Device (page 14)

Auto Answer Bluetooth Incoming Call (page 15)

Apple CarPlay (page 15)

Displaying Bluetooth Information

[Bluetooth Information] is selected on the Connection Setup Menu screen.

You can display the Bluetooth device name and device address of this unit.

Setting item:

Bluetooth Information

Pairing the Bluetooth Device

[Set Bluetooth Device] is selected on the Connection Setup Menu screen.

Search for Bluetooth compatible devices.

Setting item:

Set Bluetooth Device

1 Touch [Set Bluetooth Device].

The Bluetooth Setup screen is displayed.

- You can also display the Bluetooth Setup screen directly by touching the [Bluetooth Settings] widget on the HOME screen.

2 Select this unit on the Bluetooth device.

A message about the device to be registered is displayed.

3 Touch [Yes].

The Bluetooth device is connected.

If you connecting to a smartphone, a message to download the phonebook is displayed.

4 Touch [🎵] (Audio) or/and [📞] (Hands-free) of the device you want to connect from the list.

Audio: Device is used as an Audio device.

Hands-free: Device is used as a Hands Free Device.

- You can register up to 5 Bluetooth compatible mobile phones.
- You can connect 1 Bluetooth Device to each of Bluetooth Audio mode and Hands-free mode.
- The Bluetooth registration process differs depending on the device version and SSP (Simple Secure Pairing). If a 4 or 6 character Passcode appears on this system, enter the Passcode on the Bluetooth device.

- If a 6 character Passkey appears on this device, make sure the same passkey is displayed on the Bluetooth compatible device and touch [OK].
- If all 5 devices have been registered, you cannot register a 6th device. To register another device, you need to delete one of the other 5 devices first.

Setting the Bluetooth Device

Select one of 5 paired Bluetooth compatible devices that you previously registered.

Touch [🎵] (Audio) or [👉] (Hands-free) of the device you want to connect from the Paired Device list.

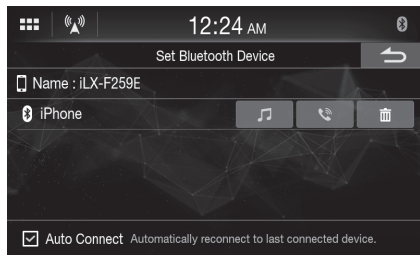

- You can also change the connected device by touching the device name.

Deleting a Bluetooth Device from the list

You can delete the information of a previously connected Bluetooth compatible device.

- 1 Touch [🗑️] of the Bluetooth compatible device to delete from the Paired Device list.
- 2 Touch [Yes].

- Touching [No] will cancel the setting.

Setting the Auto Connection

You can connect the last connected device automatically.

Set "Auto Connect" to [On] (☑).

Auto Answering Setup

You can set to answer an incoming call automatically.

Touch [🔴] (Off) or [🟢] (On) of "Auto Answer Bluetooth Incoming Call".

Apple CarPlay Setup

To use the Apple CarPlay (page 22), set "Apple CarPlay" to [On].

Touch [🔴] (Off) or [🟢] (On) of "Apple CarPlay".

Camera Setup

[Camera] is selected on the Setup Menu screen. You can set up items related to the Camera.

Camera Setup Menu screen

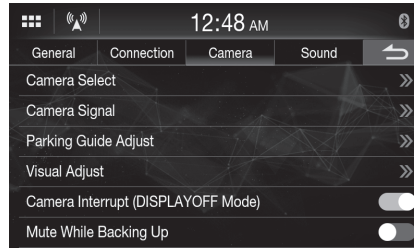

Setting items:

Camera Select (page 15)

Camera Signal (page 15)

Parking Guide Adjust (page 16)

Visual Adjust (page 16)

Camera Interrupt (DISPLAY OFF Mode) (page 16)

Mute While Backing Up (page 16)

Camera Input Setting

[Camera Select] is selected on the Camera Setup Menu screen.

Setting item:

Camera Select

Setting contents:

Off (Initial setting) / Rear

Off: No camera is connected.

Rear: Rear camera is connected.

Camera Signal Input Setting

[Camera Signal] is selected on the Camera Setup Menu screen.

When the camera is connected, the video input signal type can be chosen.

Further setting item:

Camera Signal

Setting contents:

NTSC (Initial setting) / PAL

Rear Camera Guide Settings

[**Parking Guide Adjust**] is selected on the Camera Setup Menu screen. You can adjust the camera guide position.

Setting item:

Parking Guide Adjust

1 Touch [Parking Guide Adjust] on the Camera Setup menu screen.

The camera guide adjustment screen is displayed.

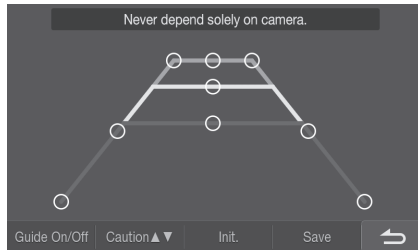

2 Slide [○] to adjust.

3 After the adjustment is completed, touch [Save].

- Touching [**Init.**] clears adjustments and returns to the setting before guide line alteration.

4 Touch [↩] to complete the adjustment and return to the previous screen.

Turning the Rear Camera Guide On/Off

When displaying the rear camera view on the screen, you can set to hide or show the camera guide.

Setting item:

Guide On/Off

Setting contents:

Off/On

Adjusting the Caution Position

You can move the position of the displaying message on the screen.

Setting item:

Caution ▲ ▼

Camera Picture Quality Setup

[**Visual Adjust**] is selected on the Camera Setup Menu screen. You can adjust the picture quality for the primary and secondary cameras.

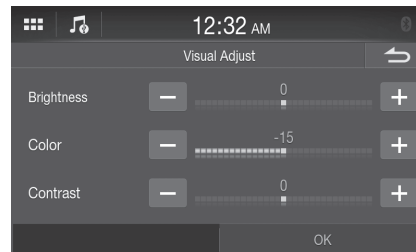

Setting item:

Visual Adjust

Adjusting Brightness

Setting item:

Brightness

Setting contents:

-15 to 15 (Initial setting: 0)

- You can adjust the brightness between MIN (-15) and MAX (+15).

Adjusting Color of Display

Setting item:

Color

Setting contents:

-15 to 15 (Initial setting: 0)

- You can adjust the color between MIN (-15) and MAX (+15).

Adjusting Display Contrast

Setting item:

Contrast

Setting contents:

-15 to 15 (Initial setting: 0)

- You can adjust the contrast between MIN (-15) and MAX (+15).

Camera Interrupt Setting (DISPLAY OFF Mode)

You can set whether to display the rear camera image when the gear lever is moved to the reverse (R) position while the unit is turned off.

Setting item:

Camera Interrupt (DISPLAYOFF Mode)

To set Display Off Mode, touch [] (Off) or [] (On) of "Camera Interrupt (DISPLAYOFF Mode)".

Mute Setting

You can set the sound will be muted automatically when the gear lever is moved to the reverse (R) position.

Setting item:

Mute While Backing Up

To set the rear speaker to On, touch [] (Off) or [] (On) of "Mute While Backing Up".

Sound Setup

[Sound] is selected on the Settings menu screen. You can set up items related to the sound quality.

■ Sound Setup Menu screen

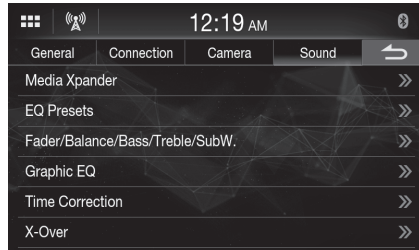

Setting items:

Media Xpander (page 17)

EQ Presets (page 17)

Fader/Balance/Bass/Treble/SubW. (page 17)

Graphic EQ (page 18)

Time Correction (page 18)

X-Over (page 19)

Volume (page 19)

Subwoofer (page 20)

Rear Speaker (page 20)

Defeat (page 20)

Setting the Media Xpander (MX)

[Media Xpander] is selected on the Sound Setup Menu screen. Media Xpander (MX) makes vocals or instruments sound distinct regardless of the music source. The USB Flash drive and iPod, will be able to reproduce the music clearly even in cars with a lot of road noise.

Setting item:

Media Xpander

1 Touch the check box of [ALL MX].

2 Touch any of [Off] [Level 1] [Level 2] [Level 3].

- To cancel MX mode, set [Off] in step 1.
- MP3/WMA/AAC can have its own MX setting.
- When the Defeat setting is [On], you cannot perform the set up.
- The MX setting can be performed only when a source is currently selected.

Equalizer Settings

[EQ Presets] is selected on the Sound Setup Menu screen. 10 typical equalizer settings are preset at the factory for a variety of musical source material.

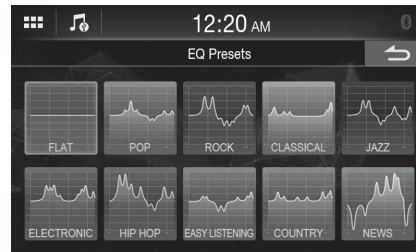

Setting item:

EQ Presets

Setting contents:

FLAT (Initial setting) / POP / ROCK / CLASSICAL / JAZZ / ELECTRONIC / HIP HOP / EASY LISTENING / COUNTRY / NEWS

- Only one type can be set to On.
- When Equalizer Presets is set, the linked Graphic EQ settings are also changed. We recommend storing Graphic EQ settings in a Preset in advance.
- The Equalizer Presets setting can be configured when Defeat is Off.

Fader/Balance/Bass/Treble/Subwoofer Settings

[Fader/Balance/Bass/Treble/SubW.] is selected on the Sound Setup Menu screen.

Setting item:

Fader/Balance/Bass/Treble/SubW.

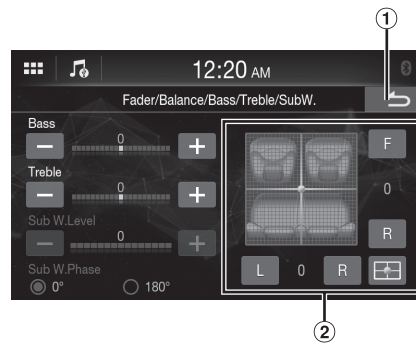

- 1 Cancel
Sound setup finishes.
- 2 Fader/Balance Image area

Setting the Fader/Balance

Touch the desired point within the image area, or touch [F] (Front), [R] (Rear), [L] (Left) or [R] (Right).

Fader:

15 (F) to 15 (R)

Balance:

15 (L) to 15 (R)

- To reset to the initial setting (F/R: 0, L/R: 0), touch [□].

Adjusting the Bass/Treble

Touch **[+]** or **[-]** for each item to be adjusted.

Setting item:
Bass, Treble

Setting contents:
-10 to 10 (Initial setting: 0)

Setting the Subwoofer

Adjusting the Subwoofer Level

Setting item:
Sub W.Level

Setting contents:
0 (Initial setting) to 15

- This setting is only available when "Subwoofer" is set to **[On]** (page 20).

Setting the Subwoofer Phase

The subwoofer output phase is toggled Subwoofer Normal (0°) or Subwoofer Reverse (180°).

Setting item:
Sub W.Phase

Setting contents:
0° (Initial setting), 180°

- This setting is only available when "Subwoofer" is set to **[On]** (page 20).

Graphic Equalizer Curve Settings (Graphic EQ)

[Graphic EQ] is selected on the Sound Setup Menu screen. You can modify the Equalizer settings to create a response curve more appealing to your personal taste.

Setting item:
Graphic EQ

Setting contents:
-7 to 7

- This setting is only available when "Defeat" is set to **[On]** (page 20).

1 Touch [Graphic EQ] on the Sound Setup menu screen.

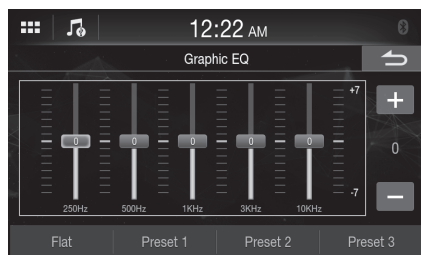

2 Touch the band to be adjusted.

3 Touch **[+]** or **[-]** to adjust the level of the band.

- You can also adjust the level of the band by moving the slider.

4 To adjust another band, repeat step 2 to 3, and adjust all bands.

5 To store the adjusted setting value, touch and hold **[Preset 1]**, **[Preset 2]**, or **[Preset 3]** for at least 2 seconds.

- Settings exceeding the frequency of adjacent bands are not available.
- While adjusting the Graphic EQ, you should consider the frequency response of the connected speakers.
- When the Graphic EQ is adjusted, the Equalizer Presets are overridden.
- When Equalizer Presets is set, the linked Graphic EQ settings are also changed. We recommend storing Graphic EQ settings in a Preset in advance.
- Touch **[Flat]** to initialize all values.

Calling the Graphic EQ adjusted value

Touch **[Preset 1]**, **[Preset 2]**, or **[Preset 3]**.

The setting stored in the Preset will be recalled.

Time Correction Settings

[Time Correction] is selected on the Sound Setup Menu screen.

Before performing the following procedures, see "About Time Correction" (page 21).



Correction mode

Setting item:
Time Correction

1 Touch [Time Correction] on the Sound Setup menu screen.

2 Touch the Correction mode button, and then select **[ms]**, **[cm]** or **[inch]**.

3 Touch **[-]** or **[+]** for each speaker to adjust the time or distance.

0.0 msec to 9.9 msec (0.1 msec/step)

0.0 cm (0.0 inch) to 336.6 cm (132.56 inch) (3.4 cm/step)

All speaker setting values are adjustable in the range of 20 ms or 680 cm.

4 To store the adjusted setting value, touch and hold **[Preset 1]**, **[Preset 2]**, or **[Preset 3]** for at least 2 seconds.

- Touch **[Flat]** to set all values to 0.0.
- If the Rear Speaker setting is Off, the Rear Speaker setting cannot be edited (page 20).
- If the Subwoofer setting is Off, the Subwoofer setting cannot be edited (page 20).

Calling the Time Correction Value

Calling the pre-set time correction value.

Touch **[Preset 1]**, **[Preset 2]**, or **[Preset 3]** on the time correction screen.

The setting stored in the Preset will be recalled.

Crossover Settings (X-Over)

[X-Over] is selected on the Sound Setup Menu screen.
Before performing the following procedures, see “About the Crossover” (page 20).



Setting item:
X-Over

- 1 Touch [X-Over] on the Sound Setup menu screen.
- 2 Touch [Channel], and then select [Front HPF], [Rear HPF] or [SubW.LPF].
- 3 Adjust the crossover to your preference.

Selecting the Cut-Off Frequency

Touch [◀] or [▶] of “Freq.” (Frequency), and then select the cut-off frequency.

Setting contents:
20.0 / 25.0 / 31.5 / 40.0 / 50.0 / 63.0 / 80.0 (Initial setting) / 100.0 / 125.0 / 160.0 / 200.0 Hz

Adjusting the Slope

Touch [◀] or [▶] of “Slope”, and then adjust the HPF or LPF slope.

Setting contents:
0 (Initial setting) / 6 / 12 / 18 / 24 dB/oct.

Adjusting the Level

Touch [–] or [+] of “Level”, and then adjust the HPF or LPF level.

Setting contents:
–12 to 0 dB (Initial setting: 0)

- 4 Repeat steps 2 to 3 to make adjustment to the other channels.
- 5 To store the adjusted setting value, touch and hold [Preset 1], [Preset 2], or [Preset 3] for at least 2 seconds.

- Touch [Flat] to initialize all values.
- If the Rear Speaker setting is Off, the Rear Speaker setting cannot be edited (page 20).
- If the Subwoofer setting is Off, the Subwoofer setting cannot be edited (page 20).
- While adjusting the X-Over you should consider the frequency response of the connected speakers.

Calling the X-Over adjusted value

Touch [Preset 1], [Preset 2], or [Preset 3].

The setting stored in the Preset will be recalled.

Volume Setup

[Volume] is selected on the Sound Setup menu screen.

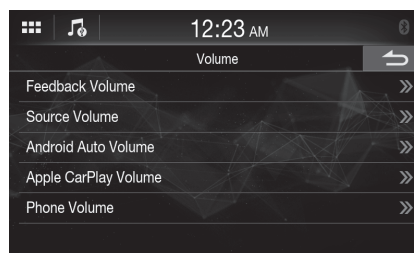

- Settable source differs depending on the connected device and settings.

Adjusting the Key Sound

You can change the volume of the sound heard when a button is touched.

Setting item:
Feedback Volume

Setting contents:
0 to 7 (Initial setting: 4)

Adjusting the Source Volume

Touch [Source Volume] on the Volume Setup menu screen.

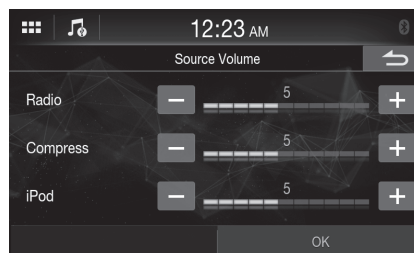

Setting item:
Radio / Compress* / iPod / Bluetooth Audio

Setting contents:
0 to 11 (Initial setting: 5)

* Compressed Media is the music data in a USB flash drive (MP3/WMA/AAC/FLAC/WAV).

Setting the Volume for Android Auto

When an Android Smartphone is connected, touch [Android Auto Volume] to set the volume for Android Auto mode.

Setting item:
Entertainment / Notification

Setting contents:
0 to 11 (Initial setting: 5)

Setting the Volume for Apple CarPlay

When an iPhone 5s or later is connected, touch [Apple CarPlay Volume] to set the volume for Apple CarPlay mode.

Setting item:

Entertainment / Notification / Ringtone / Phone Calls

Setting contents:

0 to 11 (Initial setting: 5)

Adjusting the Volume for Phone

You can adjust the speaker volume and receive volume, during the call.

Setting item:

Speaker Volume / Mic Level / Ringtone Volume

Setting contents:

0 to 11 (Initial setting: 5)

Turning Subwoofer ON/OFF

If an optional subwoofer is connected to the unit, make the following setting.

Setting item:

Subwoofer

To set the rear speaker to On, touch [] (Off) or [] (On) of "Subwoofer".

Rear Speaker Setting

You can set the rear speaker output to Off.

Setting item:

Rear Speaker

To set the rear speaker to On, touch [] (Off) or [] (On) of "Rear Speaker".

Defeat Setting

If Defeat is On, the Equalizer setting are turned Off. This disables any settings made for these functions.

Setting item:

Defeat

To set the rear speaker to On, touch [] (Off) or [] (On) of "Defeat".

About the Crossover

Crossover (X-Over):

This unit is equipped with an active crossover. The crossover limits the frequencies delivered to the outputs. Each channel is controlled independently. Thus, each speaker pair can be driven by the frequencies for which they have been optimally designed.

The crossover adjusts the HPF (high pass filter) or LPF (low pass filter) of each band, and also the slope (how fast the filter rolls off the highs or lows).

Adjustments should be made according to the reproduction characteristics of the speakers. Depending on the speakers, a passive network may not be necessary. If you are unsure about this point, please consult your authorized Alpine dealer.

	Cut-off frequency (1/3 octave steps)		Slope		Level
	HPF	LPF	HPF	LPF	
Subwoofer (LPF)	----	20 Hz - 200 Hz	----	0, 6, 12, 18, 24 dB/oct.	0 to -12 dB
Rear speaker (HPF)	20 Hz - 200 Hz	----	0, 6, 12, 18, 24 dB/oct.	----	0 to -12 dB
Front speaker (HPF)	20 Hz - 200 Hz	----	0, 6, 12, 18, 24 dB/oct.	----	0 to -12 dB

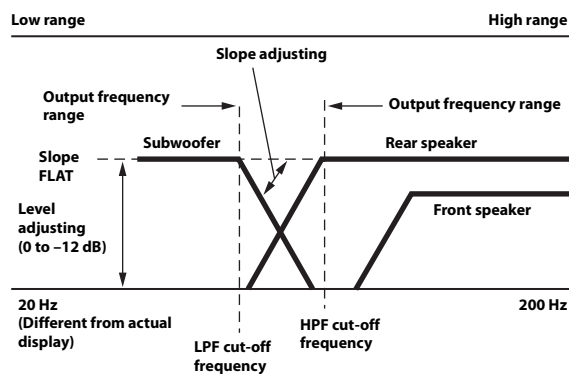

- **HPF (high pass filter):** Cuts the lower frequencies and allows the higher frequencies to pass.
- **LPF (low pass filter):** Cuts the higher frequencies and allows the lower frequencies to pass.
- **Slope:** The level change (in dB) for a frequency change of one octave.
- The higher the slope value, the steeper the slope becomes.
- Adjust the slope to FLAT to bypass the HP or LP filters.
- Do not use a tweeter without the HPF on or set to a low frequency, as it may cause damage to the speaker due to the low frequency content.
- Adjustment should be made according to the recommended crossover frequency of the connected speakers. Determine the recommended crossover frequency of the speakers. Adjusting to a frequency range outside that recommended may cause damage to the speakers. For the recommended crossover frequencies of Alpine speakers, refer to the respective Owner's Manual. We are not responsible for damage or malfunction of speakers caused by using the crossover outside the recommended value.

About Time Correction

The distance between the listener and the speakers in a car vary widely due to the complex speaker placement. This difference in the distances from the speakers to the listener creates a shift in the sounds image and frequency characteristics. This is caused by the time delay between the sound reaching the listener's right versus the left ear.

To correct this, this unit is able to delay the audio signal to the speakers closest to the listener. This effectively creates a perception of increased distance for those speakers. The listener can be placed at an equal distance between the left and right speakers for optimum staging. The adjustment will be made for each speaker in 3.4 cm steps.

Example 1. Listening Position: Front Left Seat

Adjust the time correction level of the front left speaker to a high value and the rear right to zero or a low value.

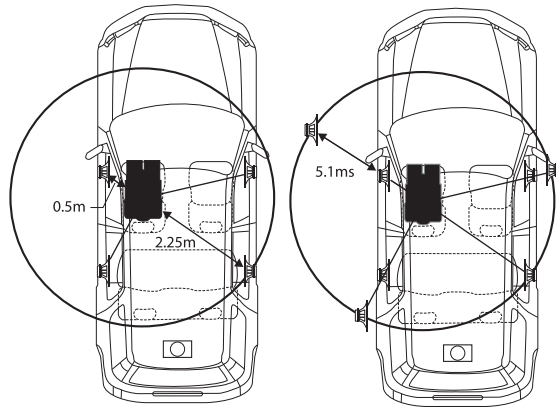

The sound is not balanced because the distance between the listening position and the various speakers is different. The difference in distance between the front left speaker and the rear right speaker is 1.75 m (68-7/8"). Here we calculate the time correction value for the front left speaker in the diagram on the above.

Conditions:
 Farthest Speaker – listening position : 2.25 m (88-9/16")
 Front left speaker – listening position : 0.5 m (19-11/16")
 Calculation: $L = 2.25 \text{ m} - 0.5 \text{ m} = 1.75 \text{ m}$ (68-7/8")
 Time correction = $1.75 \div 343 * \times 1,000 = 5.1 \text{ (ms)}$

* Speed of sound: 343 m/s (765 mph) at 20°C

In other words, giving the front left speaker a time correction value of 5.1 ms makes it seem as if its distance from the listener is the same as the distance to the farthest speaker.

Time correction eliminates the differences in the time required for the sound to reach the listening position. The time of the front left speaker is corrected by 5.1 ms so that its sound reaches the listening position at the same time as the sound of other speakers.

Example 2. Listening Position: All Seats

Adjust the time correction level of each speaker to almost the same level.

- 1 Sit in the listening position (driver's seat, etc.) and measure the distance (in meters) between your head and the various speakers.
- 2 Calculate the difference between the distance correction value to the farthest speaker and the other speakers.

$$L = (\text{distance to farthest speaker}) - (\text{distance to other speakers})$$

These values are the time correction values for the different speakers. Setting these values to make each sound reach the listening position at the same time as the sound of other speakers.

Time Correction Value List

Time Difference (msec)	Distance (cm)	Distance (inch)	Time Difference (msec)	Distance (cm)	Distance (inch)
0.0	0.0	0.0	5.1	173.4	68.3
0.1	3.4	1.3	5.2	176.8	69.7
0.2	6.8	2.7	5.3	180.2	71.0
0.3	10.2	4.0	5.4	183.6	72.4
0.4	13.6	5.4	5.5	187.0	73.7
0.5	17.0	6.7	5.6	190.4	75.0
0.6	20.4	8.0	5.7	193.8	76.4
0.7	23.8	9.4	5.8	197.2	77.7
0.8	27.2	10.7	5.9	200.6	79.1
0.9	30.6	12.1	6.0	204.0	80.4
1.0	34.0	13.4	6.1	207.4	81.7
1.1	37.4	14.7	6.2	210.8	83.1
1.2	40.8	16.1	6.3	214.2	84.4
1.3	44.2	17.4	6.4	217.6	85.8
1.4	47.6	18.8	6.5	221.0	87.1
1.5	51.0	20.1	6.6	224.4	88.4
1.6	54.4	21.4	6.7	227.8	89.8
1.7	57.8	22.8	6.8	231.2	91.1
1.8	61.2	24.1	6.9	234.6	92.5
1.9	64.6	25.5	7.0	238.0	93.8
2.0	68.0	26.8	7.1	241.4	95.1
2.1	71.4	28.1	7.2	244.8	96.5
2.2	74.8	29.5	7.3	248.2	97.8
2.3	78.2	30.8	7.4	251.6	99.2
2.4	81.6	32.2	7.5	255.0	100.5
2.5	85.0	33.5	7.6	258.4	101.8
2.6	88.4	34.8	7.7	261.8	103.2
2.7	91.8	36.2	7.8	265.2	104.5
2.8	95.2	37.5	7.9	268.6	105.9
2.9	98.6	38.9	8.0	272.0	107.2
3.0	102.0	40.2	8.1	275.4	108.5
3.1	105.4	41.5	8.2	278.8	109.9
3.2	108.8	42.9	8.3	282.2	111.2
3.3	112.2	44.2	8.4	285.6	112.6
3.4	115.6	45.6	8.5	289.0	113.9
3.5	119.0	46.9	8.6	292.4	115.2
3.6	122.4	48.2	8.7	295.8	116.6
3.7	125.8	49.6	8.8	299.2	117.9
3.8	129.2	50.9	8.9	302.6	119.3
3.9	132.6	52.3	9.0	306.0	120.6
4.0	136.0	53.6	9.1	309.4	121.9
4.1	139.4	54.9	9.2	312.8	123.3
4.2	142.8	56.3	9.3	316.2	124.6
4.3	146.2	57.6	9.4	319.6	126.0
4.4	149.6	59.0	9.5	323.0	127.3
4.5	153.0	60.3	9.6	326.4	128.6
4.6	156.4	61.6	9.7	329.8	130.0
4.7	159.8	63.0	9.8	333.2	131.3
4.8	163.2	64.3	9.9	336.6	132.7
4.9	166.6	65.7			
5.0	170.0	67.0			

Apple CarPlay (Optional)

Apple CarPlay is a smarter, safer way to use your iPhone in the car. Apple CarPlay takes the things you want to do with your iPhone while driving and puts them right on the unit. You can get directions, make calls, send and receive messages, and listen to music, all in a way that allows you to stay focused on the road. Just plug in your iPhone to the unit and go.

- Before using this function, plug in your iPhone using Lightning to USB Cable (Supplied with iPhone) to the unit.
- Some functions may not be available while driving.
- About iPhone models usable with this unit, see “iPod mode on iPhone (Optional)” (page 27). Only an iPhone 5s or later compatible with Apple CarPlay function.
- Before operating Apple CarPlay, set “Apple CarPlay” to [On] (page 15).

Access to Apple CarPlay

1 Touch the (HOME) button.

The HOME screen is displayed.

2 Touch [Apple CarPlay].

The Apple CarPlay screen is displayed.

Touch the desired App icon on the unit, or use Siri function by touching the  button.

- When a used iPhone 5s or later is reconnected, touch the pop-up message-“Apple CarPlay connected.” within 5 seconds to access to Apple CarPlay screen, or you can ignore prompt by touching [] on the top right.
- The App must be Apple CarPlay compatible in order to appear in the Home screen.

Android Auto (Optional)

What is Android Auto

Android Auto is designed to make it easier to use apps from your phone while you're on the road. Navigate with Google Maps, listen to playlists or podcasts from your favorite apps, and more.

Activate Android Auto

Download the Android Auto App from the Google Play store before continuing.

Just plug in your smartphone to the unit's USB connector, then follow the prompt to pair your smartphone with the unit.

- The connected smartphone with Android Auto will disconnect other phone's Bluetooth connection and pair to the unit.

1 Touch the (HOME) button.

The HOME screen is displayed.

2 Touch [Android Auto].

The Android Auto screen is displayed.

- When a used smartphone is reconnected, touch the pop-up message-“Android Auto connected” within 5 seconds to access to Android Auto screen, or you can ignore prompt by touching [] on the top right.
- You can make a call, use voice recognition function and Android Auto's compatible navigation app, etc.
- Only Google approved apps with necessary driver-safety measures in place can be used.

Radio

There are 3 types of [Radio] widgets for the HOME screen.

Radio main screen example

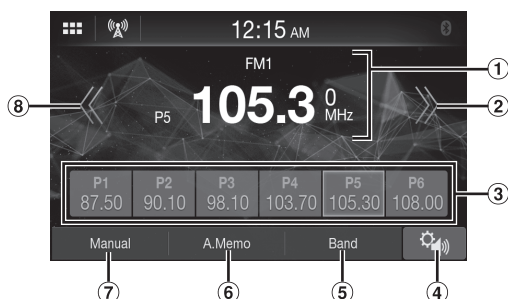

- ① Information display
- ② Increases frequency
Touch and hold to change the frequency continuously.
- ③ Preset button
Displays the preset stations with a short touch.
Touch for at least 1 second to memorize the current station as a preset station.
- ④ Displays the Sound Setup Menu screen (page 17).
- ⑤ Switches a band.
- ⑥ Memorizes stations automatically
- ⑦ Switches a Seek mode.
- ⑧ Decreases frequency
Touch and hold to change the frequency continuously.

Radio Basic Operation

Listening to the Radio

- 1 Touch the [HOME] button and select radio mode.**
The display shows the radio mode screen.
- 2 Touch [Band] repeatedly to select the desired band from [FM1] / [FM2] / [AM].**
- 3 Touch [DX Seek], [Local Seek] or [Manual] repeatedly to select the tuning mode.**
The radio frequency up or down button changes depending on the tuning mode.

DX Seek (Distance) mode*	Automatically receives a receivable digital broadcast. Both strong and weak stations will be tuned in.
Local Seek mode*	Automatically receives a strong digital broadcast only.
Manual mode	The frequency is manually tuned in steps.

 - During Forced Analog mode, digital broadcasts cannot be received.

* Depending on the signal, a digital or analog broadcast is received.
- 4 Touch [Left Arrow], [Right Arrow], [Left Arrow], [Right Arrow] to change the radio frequency up or down respectively.**
In Manual mode, touch and hold to change the frequency continuously.

Presetting Stations Manually

- 1 Tune in a desired radio station you wish to store in the preset memory by manual or automatic seek tuning.**
- 2 Touch and hold the Preset number you want to store for at least 1 second.**
The selected station is stored.
- 3 Repeat the procedure to store up to 5 other stations onto the same band.**
To use this procedure for other bands, simply select the desired band and repeat the procedure.

A total of 18 stations can be stored in the preset memory (6 stations for each band; FM1, FM2 or AM).
 - If a preset memory has already been set in the same preset number, it will be cleared and the new station will be memorized.

Presetting Stations Automatically

The tuner can automatically seek and store 6 strong stations in the selected band in ascending order of frequency.

Select the desired band then touch and hold [A.Memo].

The tuner automatically seeks and stores 6 strong stations into the preset buttons in ascending order of frequency. When automatic storing has completed, the station stored in the preset 1 is selected.

- If no stations are stored, the tuner will return to the original station you were listening to before the automatic storing procedure began.
- You can cancel this process by touching [A.Memo] while the tuner is automatically seeking stations. Canceling will return the tuner preset to the previous setting.

Tuning to Preset Station

After selecting the desired band, touch the desired preset button.

The preset station is received.

USB Flash drive (Optional)

You can play back music files (MP3/WMA/AAC/FLAC/WAV), video files (MP4/AVI/WMV/MOV) and photo files (JPG/PNG/BMP) stored in a USB flash drive on the internal player of this system.

⚠ WARNING

It is dangerous for the driver to watch video while driving the vehicle. The driver may be distracted from looking ahead and an accident could occur.

Install the unit correctly so that the driver cannot watch a video unless the car is stopped and the parking brake is applied.

If the unit is not installed correctly, the driver will be able to watch a video while driving and may be distracted from looking ahead and cause an accident. The driver or other people could be severely injured.

USB Audio

■ USB Audio mode screen

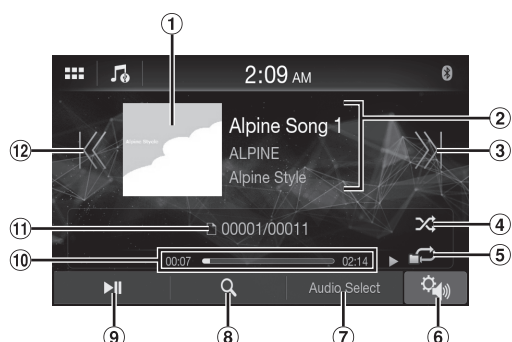

- ① Artwork display
- ② Information display
- ③ Finds the beginning of next chapter/Fast-forwards when touched for at least 1 second
- ④ Shuffle mode
- ⑤ Repeat mode
- ⑥ Displays the Sound Setup Menu screen (page 17)
- ⑦ Switches to iPod mode of iPhone or Bluetooth Audio.
- ⑧ Displays the search screen
- ⑨ Pause and Play
- ⑩ Elapsed time/Total time for playing
- ⑪ Current track number/Total track number
- ⑫ Finds the beginning of the current file/Finds a previous file within one second after playback starts/Fast-reverses when touched for at least 1 second

Playback

- 1 Touch the (HOME) button and select USB Audio mode.**

The display shows the USB Audio mode screen.

- 2 Touch [] or [] to select the desired track (file).**

Returning to the beginning of the current (or previous) track (file):
Touch [].

Fast reverse :

Touch and hold [].

Advancing to the beginning of the next track (file) :

Touch [].

Fast forward :

Touch and hold [].

- 3 To pause playback, touch [].**

Touching [] again will resume playback.

- The playback time may not be correctly displayed when a VBR (Variable Bit Rate) recorded file is played back.
- If there is tag information, artist name/album name/track name is displayed.
- ID3 tag/WMA tag
If an MP3/WMA/AAC/FLAC/WAV file contains ID3 tag/WMA tag information, the ID3 tag/WMA tag information is displayed. (e.g., song name, artist name, and album name)
- When selecting a [Audio] widget on the HOME screen, touch [Audio Select] to select [USB]. If [USB] is already selected, you can start playback by selecting a [Audio] widget on the HOME screen.

Fast-forwarding/Fast-reversing

- 1 During playback, touch and hold [] (Fast-reverse) or touch and hold [] (Fast-forward).**

Touch and hold for more than 1 second to forward/reverse at 8x speed. Keep touching to switch the speed to 16x and 32x.

- 2 Release [] or [] to return to normal playback.**

- No sound is played back during fast-forwarding/fast-reversing.

Repeat Play

Touch [], [] or [] to select Repeat Play mode.

ALL : All files are repeatedly played back.

File : Only the file currently playing is repeatedly played back.

Folder : Only files in a folder are repeatedly played back.

Shuffle Play

Touch [🔀] to select Shuffle Play mode.

Folder 🔄: A Folder is selected randomly and songs in the Folder are played back in order. After all songs are played in a Folder, the next Folder is selected randomly.

Song 🔄: All songs in the Folder (Folder/File) including the song currently being played are played back in random sequence.

OFF 🔄: Shuffle mode is Off.

- If you select a track by using the search mode, the Shuffle mode will be canceled.

Searching for a Desired Song

1 Touch [🔍] (Search).

2 Touch your desired Folder name or File name.

When you select a Folder name, repeat the same procedure to select another Folder name or File name.

USB Video

The video formats (USB Flash drive) supported by the unit are as follows.

- Supported Container: AVI/MP4/WMV/MOV/MPG
- Supported Video Coding: H.264/MPEG-4 AVC
- Supported Audio Coding: MP3, AAC, MPEG2 audio
- MAX File Size: 4GB

■ USB Video mode screen

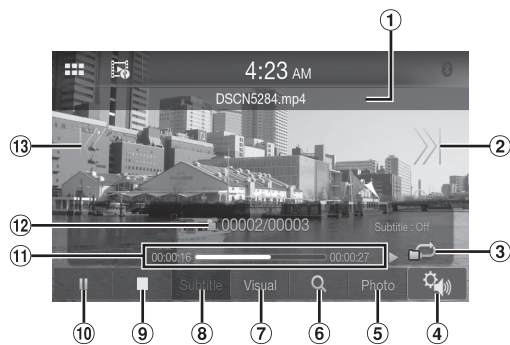

- 1 File Name
- 2 Finds the beginning of next file/Fast-forwards when touched for at least 1 second
- 3 Shuffle mode
- 4 Displays the Sound Setup Menu screen (page 17)
- 5 Switches to USB Photo mode
- 6 Displays the search screen
- 7 Sets the Brightness and Contrast
- 8 Displays the Subtitle
- 9 Stop
- 10 Pause and Play
- 11 Elapsed time/Total time for playing
- 12 Current file number/Total file number
- 13 Finds the beginning of the current file/Finds a previous file within one second after playback starts/Fast-reverses when touched for at least 1 second

For the basic operations on USB Video mode, refer to "Playback" (page 24), "Fast-forwarding/Fast-reversing" (page 24) and "Searching for a Desired Song" (page 25). Select "USB Video mode" instead for "USB Audio mode."

- To select USB Video mode, touch the [USB Video] or [Video] widget on the HOME screen.
- When searching for a desired video, touch [Repeat videos] for Repeat mode.

During the USB Video playback, touch the screen to display the operation screen.

- The operation screen changes to the visual screen in the USB Video mode for 5 seconds after an operation has been performed.
- For your safety, video is not displayed and only audio can be heard while driving.

Setting the Brightness and Contrast

1 Touch [Visual].

2 Touch [+] or [-] to adjust the Brightness and Contrast.

☼: Adjusting the Brightness

⦿: Adjusting the Contrast

Displaying the Subtitle

Depending on the video file such as ".smi" or ".srt", you can display the subtitle contained on the file.

Touch [Subtitle].

To cancel displaying the subtitle, touch [Subtitle] again.

- If the file is not supported or the subtitle is not contained on the file, [Subtitle] is not available.

USB Photo

■ USB Photo mode Preview screen

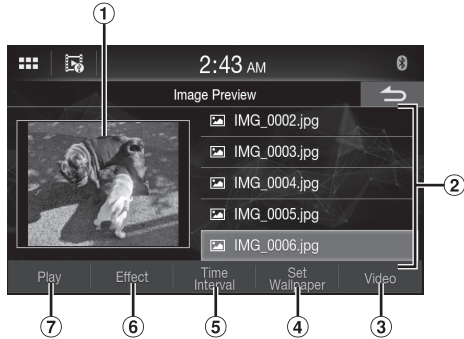

■ USB Photo mode screen

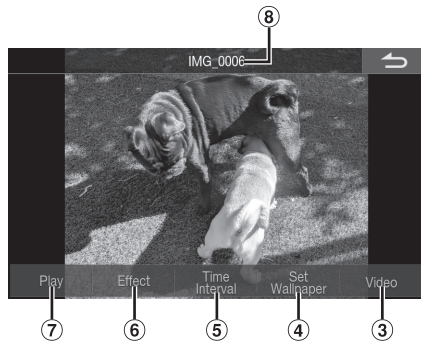

- ① Photo Preview
- ② Photo files List
- ③ Switches to USB Video mode
- ④ Sets the photo as a wallpaper (page 12)
- ⑤ Sets the Time Interval for the Slide Show
- ⑥ Applies an Effect to the photo
- ⑦ Plays the Slide Show
- ⑧ File Name

During the USB Photo playback, touch the screen to display the operation screen.

- The operation screen changes to the visual screen in the USB Photo mode for 5 seconds after an operation has been performed.

Playback

1 Touch the (HOME) button and select USB Photo mode.

The display shows the USB Photo mode screen.

- To select USB Photo mode, touch the [Photo] or [Photo Frame] widget on the HOME screen.

2 Select the desired photo from the photo files list.

- To select the other photo (file), touch [] to return to the previous screen.

Slide Show

The Slide Show shows photos that change every 3 seconds.

Touch [Play].

- To stop the Slide Show, touch the screen.

Setting the Effect for Playback

You can set the playback effect how switches to the photo for Slide Show.

Touch [Effect], and then select the desired effect.

Setting the Time Interval for Slide Show

You can set the time interval to switch to the next photo.

Touch [Time Interval], and then select the desired time interval.

Setting a Wallpaper with a Photo

To set a wallpaper with your favorite photo, refer to “Setting a Wallpaper using your image” (page 12).

iPod mode on iPhone (Optional)

A separately sold Lightning to USB cable (KCU-471i), etc., is required.

- This unit does not support video playback from iPhone which connected to this unit via USB Connector.
- Internet or telephone function, etc., of the iPhone is not controllable from the unit, but these functions can be controlled using the iPhone itself.
- Before operating iPod mode on iPhone, set "Apple CarPlay" to [Off] (page 15).

About iPhone models usable with this unit

- The following devices have been tested and shown to work with this unit. Correct function of earlier versions cannot be guaranteed.
 - iPhone X
 - iPhone 8
 - iPhone 8 Plus
 - iPhone 7
 - iPhone 7 Plus
 - iPhone SE
 - iPhone 6s
 - iPhone 6s Plus
 - iPhone 6
 - iPhone 6 Plus
 - iPhone 5s

■ iPod main screen example

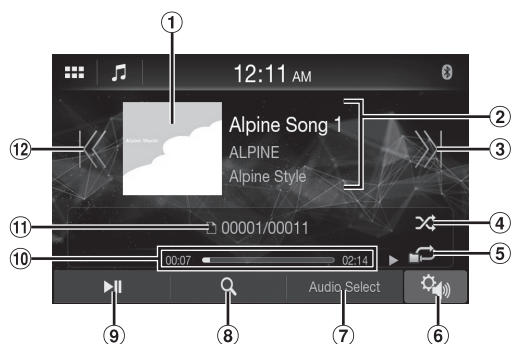

- ① Artwork display
- ② Information display*
- ③ Finds the beginning of the current file/Finds a previous file within one second after playback starts/Fast-reverses when touched for at least 1 second
- ④ Shuffle mode
- ⑤ Repeat mode
- ⑥ Displays the Sound Setup Menu screen (page 17).
- ⑦ Switches to the USB Flash drive or Bluetooth Audio.
- ⑧ Displays the search screen
- ⑨ Pause and Play
- ⑩ Elapsed time/Total time for playing
- ⑪ Current song no./Total song no.
- ⑫ Finds the beginning of the current file/Finds a previous file within one second after playback starts/Fast-reverses when touched for at least 1 second

* Podcast mode.

Playback

1 Touch the  (HOME) button and select iPod mode.
The display shows the iPod mode screen.

2 Touch [] or [] to select the desired track (file).



Returning to the beginning of the current (or previous) track (file):
Touch [].

Fast reverse the current track :
Touch and hold [].

Advancing to the beginning of the next track (file) :
Touch [].

Fast forward the current track :
Touch and hold [].

3 To pause playback, touch [].

- If a song is playing on the iPhone before it is connected to the unit, it will continue playing when it is connected.
- An episode may have several chapters. The chapter can be changed by touching [] or [].
- If the artist, album or song name, created in iTunes, has too many characters, songs may not be played back when connected to the unit. Therefore, a maximum of 64 characters is recommended. The maximum number of characters for the unit is 64.
- Some characters may not be correctly displayed.
- When selecting a [Audio] widget on the HOME screen, touch [Audio Select] to select [iPod]. If [iPod] is already selected, you can start playback by selecting a [Audio] widget on the HOME screen.

Searching for a Music File

An iPhone can contain thousands of songs. For this reason, this unit can make various searches using the search function as shown below. Using the Playlist/Artist/Album/Podcast/Audiobook/Genre/Composer/Song/Radio search mode's individual hierarchy, you can narrow down your search as shown in the table below.
<Music Search Menu>

Hierarchy 1	Hierarchy 2	Hierarchy 3	Hierarchy 4
Playlists	Songs	—	—
Artists	Albums	Songs	—
Albums	Songs	—	—
Songs	—	—	—
Genres	Artists	Albums	Songs
Composers	Albums	Songs	—
Podcasts	Episodes	—	—
Audiobooks	—	—	—
Radio	—	—	—

For example: Searching by Artist name

The following example explains how an Artists search is performed.

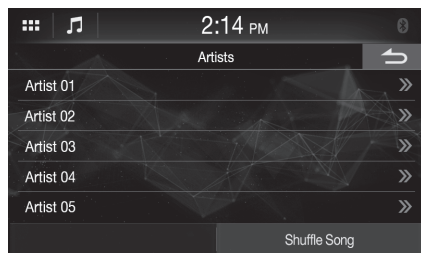

1 Touch [Q] (Search) during playback.

2 Touch [Artists].

The Artists search screen is displayed.

3 Select the desired artist.

4 Touch the desired album's name.

All songs of the selected album are displayed.

5 Touch the desired song's name.

The selected song is played back.

Repeat Play

Touch [↺] to select Repeat Play mode.

ALL : All files are repeatedly played back.

File : Only the file currently playing is repeatedly played back.

OFF : Repeat mode is Off.

Shuffle Play

1 Touch [↻] to select Shuffle Play mode.

Songs : Song shuffle randomly plays back songs within a selected category (playlist, album, etc.). The songs within the category are played just once until all songs have been played.

OFF : Shuffle mode is Off.

Bluetooth Operation

Setup Before Using

About Bluetooth

Bluetooth is a wireless technology allowing communication between a mobile device or personal computer over short distances. This enables a hands-free call or data transmission between Bluetooth compatible devices. Bluetooth transmission is available in the unlicensed 2.4 GHz spectrum if the distance between devices is within 10 meters. For details, refer to the Bluetooth website (<http://www.bluetooth.com/>).

- Depending on the Bluetooth version, a Bluetooth compatible device may not be able to communicate with this unit.
- Proper function of this unit with all Bluetooth compatible devices is not guaranteed. For handling of the Bluetooth compatible device, consult your Alpine dealer or Alpine website.
- Depending on the surroundings, Bluetooth wireless connection may be unstable.
- When you place a call, or perform setup operations, be sure to stop your car in a safe place.
- Depending on the connected Bluetooth compatible device(s), the function may differ. Also refer to the Owner's Manual of the connected device(s).

About the Hands-free Phone

Hands-free calls are possible when using a HFP (Hands-Free Profile) compatible mobile phone with this unit.

- Avoid performing a hands-free call in heavy traffic or on narrow or winding streets.
- Close the windows while calling to reduce background noise.
- If both calling parties are using hands-free devices, or the call is made in a noisy location, difficulty hearing the other person's voice is normal.
- Depending on telephone line conditions or certain mobile devices used, voices may sound unnatural.
- When using a microphone, speak as directly as you can into the microphone to obtain the best sound quality.
- Certain mobile phone features are dependent on the capabilities and settings of your service provider's network. Additionally, certain features may not be activated by your service provider, and/or the provider's network settings may limit the feature's functionality. Always contact your service provider about feature availability and functionality.

All features, functionality, and other product specifications, as well as the information contained in the Owner's Manual are based upon the latest available information and are believed to be accurate at the time of printing.

Alpine reserves the right to change or modify any information or specifications without notice or obligation.

- Notice that when you connect an iPhone 5s or later/Android smartphone which installed Android Auto App, the operation screen may differ from this section.

Before Using Bluetooth

Before using the hands-free phone/audio function, the following settings need to be made.

Register a Bluetooth device in this unit.

- See "Connection (Bluetooth) Setup" (page 14).
- You can search for this unit using a Bluetooth compatible device, and then connect that Bluetooth compatible device to this unit. The device name of this unit is "iLX-F259" and the initial number of the passcode is "0000." Also refer to the Owner's Manual of the connected device(s).

Hands-free Phone Control

Touch the Phone button to display the Phone menu screen.

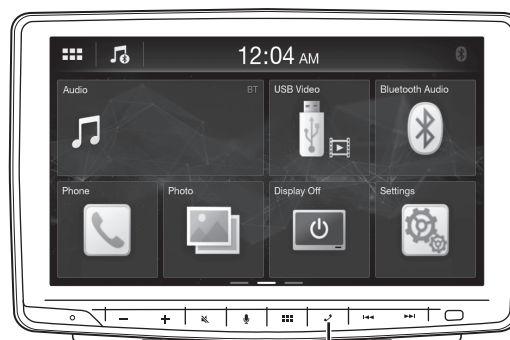

Phone button

- You can also display the Phone menu screen by selecting the [Phone] widget on the HOME screen.

Phone menu screen example

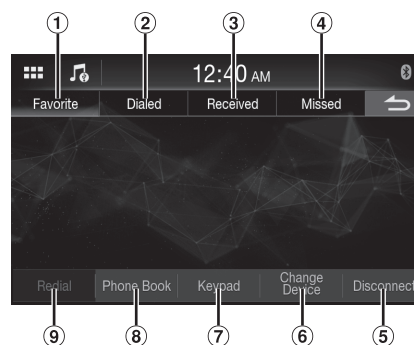

- ① Favorite
Displays a list of numbers set as your favorite.
- ② Dialed
Displays a list of dialed calls.
- ③ Received
Displays a list of the received calls.
- ④ Missed
Displays a list of the missed calls.
- ⑤ Disconnect
Disconnects the Bluetooth device. After disconnecting, the display changes to [Reconnect] to connect the disconnected device again.
- ⑥ Change Device
Displays the Bluetooth Setup screen.
- ⑦ Keypad
Use to type a phone number.

- ⑧ Phone Book*
You can make a phone call from the Phone Book, or edit the Phone Book.
- ⑨ Redial
Dials to the last called number.

* If the Hands-Free Phone is not connected, the Bluetooth Setup screen will be displayed. See "Connection (Bluetooth) Setup" (page 14).

Answering a Call

- 1 An incoming call triggers the ringtone and an incoming call display.

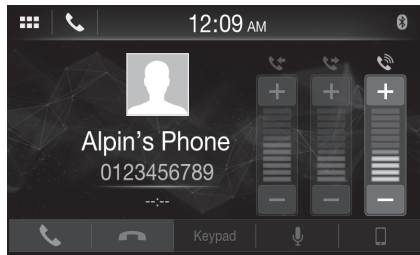

- You can adjust the ringtone volume by touching [+] or [-] of "Ringtone Volume (🔊)".

- 2 Touch [📞].
The call starts.



- During a call, the audio for the current mode on the unit is muted. After calling, playback will resume.
- When the caller's number is transmitted to the system, if the caller's name is stored in the phone book, the name is displayed. If the name is not stored, the number is displayed.
- Touch [📞] (Decline) to reject an incoming call.
- By touching [🔇], you can mute the microphone. To cancel MUTE mode, touch [🔊]. For details, see "Phone Operation Screen" (page 32).
- If another call comes during a call, operate on the Bluetooth Device.

Hanging up the Telephone

- 1 Touch [📞] (End Call).
The call finishes.

Calling

Making a phone call using the Phone Menu

Making a phone call from the Recent Events list

- 1 Select a category from [Favorite], [Dialed], [Received] or [Missed] on the Phone menu.

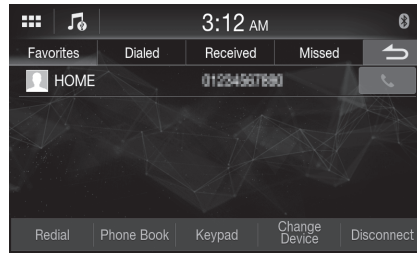

- 2 Touch [📞] of the name or number of the contact which you want to call.

- 3 Touch [Call].
The phone call is started.

- To use [Favorite], see "Setting contacts as Favorites (Shortcut Dialing)" (page 33).

Calling from the Phone Book

- 1 Touch [Phone Book] on the Phone menu.
The Phone Book screen appears.

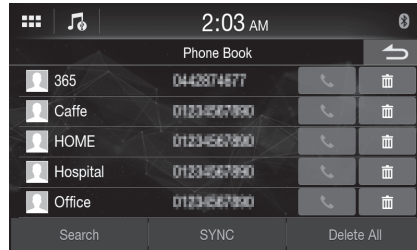

- 2 Touch [📞] of the name or number of the contact which you want to call.
The phone call is started.

Entering a Phone Number to Make a Call

- 1 Touch [Keypad] on the Phone menu.
The number input screen (Keypad) appears.

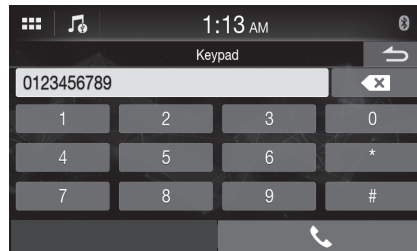

Touch [✕] to delete an entered number.

- 2 Enter the phone number you wish to call.
 - You can enter up to 21 digits.

3 Touch [📞] (Call).

A confirmation message of the phone number appears.

4 Touch [Call].

The phone call is started.

Calling in Private

When using the Private Call setting, the conversation is not output through the speaker.

Touch [📞] during the call.

- To change the Bluetooth device, touch [Change Device] to display the Bluetooth Setup screen. See "Connection (Bluetooth) Setup" (page 14).

Using Voice Recognition function

You can use Siri function of your iPhone or make a telephone call by using voice operation of your smartphone.

- When using Apple CarPlay or Android Auto, the operation screen may differ from the screen design in the Owner's Manual.

Using Siri

You can use the Siri function of your iPhone. To use this function, set the Siri setting of your iPhone to ON.

- Connect your iPhone to the unit via Bluetooth, then set to "Hands-free" (page 15).
- The available functions differ depending on the connected iPhone.
- Ask Siri to play a track from the music library applies only to USB source.
- Siri and other streaming services are enabled by connecting to compatible smartphones that are able to receive data. Please ensure that cellular data and/or Wi-Fi is turned on in the smartphone to enjoy these features.
- Extensive use of Siri or other streaming services may increase your phone's data usage. Please check with your phone company to ensure you have an appropriate Data plan.

1 Touch [📞] button.

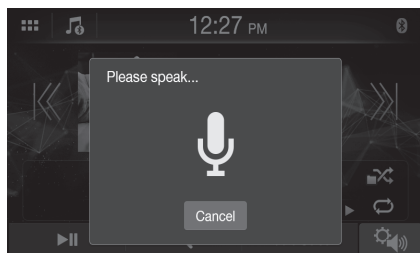

The Voice Recognition mode screen is displayed.

2 Speak into the microphone supplied with this unit.

3 To finish the Voice Control mode, touch [Cancel].

- Depending on the iPhone, the Siri function may finish automatically.
- For adjusting the volume, see "Adjusting the Speech Volume" (page 32).

Voice Dial Function

You can make a telephone call by using voice operation.

- Connect your smartphone to the unit via Bluetooth, then set to "Hands-free" (page 15).

1 Touch [📞] button.

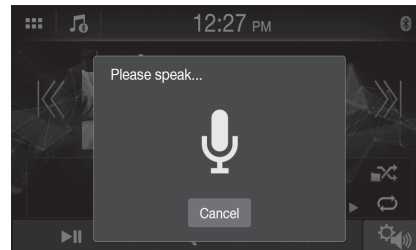

The Voice Dial mode screen is activated.

2 Say the telephone number* or name* you want to call, into the microphone.

* The number and name depend on the voice dial information stored in the smartphone.

3 To finish the Voice Dial mode, touch [Cancel].

- You can perform this operation only when a voice dial compatible smartphone is connected.
- The Voice Dial function performance depends on the recognition range of the smartphone and mounting location of the microphone. Note when the microphone is mounted.
- Voice dial operation depends on the function being available on the smartphone. For details, refer to the owner's manual of the smartphone.
- Depending on the smartphone, the Voice Dial operation may finish automatically.
- For adjusting the volume, see "Adjusting the Speech Volume" (page 32).

Phone Operation Screen



- ① Name and phone number
 - If it is registered with a Group, the Group Name is also displayed. Although, depending on the connected mobile phone, it may not be displayed.
- ② Conversation time

Adjusting the Speech Volume

You can adjust Caller Level and Microphone Level.

Touch [–] or [+] of “Speaker Volume (🔊)” or “Mic Level (🔊)”.

You can adjust the volume in 11 levels.

Changing the Voice Output

The voice output for calls is switchable between car speakers and the mobile phone speaker.

Touch [📺] or [🚗].

- Depending on the mobile phone, this operation may not be possible.

Muting the Microphone

Touch [🔇].

- To cancel MUTE mode, touch [🔊].

DTMF (Touch-Tone) Function

Transmits a DTMF (Touch-Tone) during a call.

- 1 Touch [Keypad].
The number input screen (Keypad) appears.

- 2 Input number.

- You can transmit a Touch-Tone signal during a call.

Phone Book Function

Phone Book screen example

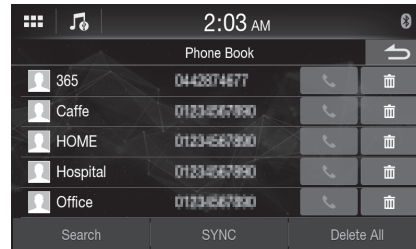

Searching in the Phone Book

You can make a call using the phone book search function.

- 1 Touch [Search] on the Phone Book screen.
The Input User Name screen (Keypad) is displayed.
- 2 Input the string of letters of the name that you want to search, then touch [OK].
A list of names beginning with the string of letters you entered is displayed.
- 3 Touch [📞] of the name or number of the contact which you want to call.
The phone call is started.

- If there are fewer than five registered items in the phone book, you cannot use the phone book search function.

Synchronizing the Phone Book

You can synchronize the system's phone book with the mobile phone's phone book.

- 1 Touch [SYNC] on the Phone Book screen.
The confirmation screen is displayed.

- 2 Touch [Yes].
Synchronization of the phone books starts.

- You can store up to 1,000 registered name in the phone book.
- You can store up to 5 phone numbers by one person's name.

Deleting the Phone Book Entries

Deleting One Entry from the Phone Book

Touch [] of the contact name (or phone number) you want to delete.

The selected number is deleted.

Deleting All Entries from the Phone Book

1 Touch [Delete All] on the Phone Book screen.

The confirmation screen is displayed.

2 Touch [Yes].

All entries of the phone book are deleted.

Setting contacts as Favorites (Shortcut Dialing)

You can set contacts from the Phone Book, Dialed, Received, and Missed list as favorites.

1 Touch the name or phone number on the list.

2 Touch [★] of "Favorites."

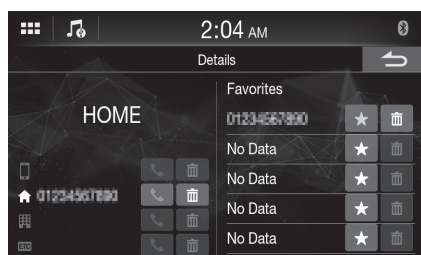

The phone number is set as a Favorite.

- Up to 5 contacts can be set as Favorites.
- If [★] has already been set with a number, touching it overwrites the number.
- To delete a contact from the Favorites list, touch [].

Bluetooth Audio

If a Bluetooth compatible mobile phone, portable player, etc. is connected by wireless, you can play back a song (operation is controllable from the unit).

- Operation may vary, depending on the Bluetooth compatible device.

Bluetooth Audio main screen example

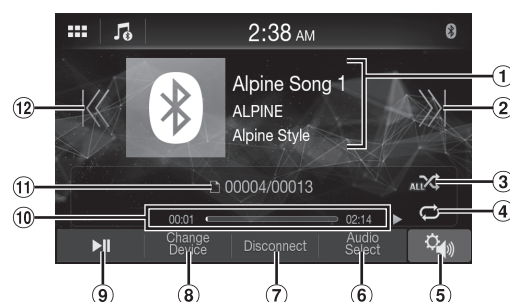

- 1 Information display
- 2 Finds the beginning of next chapter/Fast-forwards when touched for at least 1 second
- 3 Shuffle mode
- 4 Repeat mode
- 5 Displays the Sound Setup Menu screen (page 17).
- 6 Switches to the USB Flash drive or iPod mode of iPhone.
- 7 Disconnects the Bluetooth device
- 8 Changes the Bluetooth device.
- 9 Pause and Play
- 10 Elapsed time/Total time for playing
- 11 Current track number/Total track number
- 12 Finds the beginning of the current file/Finds a previous file within one second after playback starts/Fast-reverses when touched for at least 1 second

- The displayed onscreen buttons may differ depending on the AVRCP version.
- Song title/Artist title/Album title/Elapsed time do not display for AVRCP Ver. 1.0.
- To play back audio, a mobile phone or a portable player conforming to A2DP (Advanced Audio Distribution Profile) or AVRCP (Audio/Video Remote Control Profile) is required.
Not all functions work with all devices.
- During a call, sound on the Bluetooth audio source is paused.

Compatible AVRCP versions: 1.0, 1.3, 1.4, 1.5

- Available functions may differ depending on the AVRCP version.

Playback

1 Touch the  (HOME) button and select Bluetooth Audio mode.

The display shows the Bluetooth Audio mode screen.

2 Touch [] or [] to select the desired track (file).

Returning to the beginning of the current file:

Touch [].

Fast backward the current file:

Touch and hold [].

Advance to the beginning of the next file:

Touch [].

Fast forward the current file:

Touch and hold [].

3 To pause playback, touch [].

- When selecting a [Audio] widget on the HOME screen, touch [Audio Select] to select [BT]. If [BT] is already selected, you can start playback by selecting a [Audio] widget on the HOME screen.

Repeat Play

Available for AVRCP Ver. 1.4 and 1.5 only.

Touch [] repeatedly to select Repeat Play mode.

File : Only the track currently playing is repeatedly played back.

ALL : Once all of the songs have finished playing, play back is repeated, starting with the first song.

Off : Repeat mode is Off.

- Operations may differ depending on the connected Bluetooth compatible device.

Shuffle Play

Available for AVRCP Ver. 1.4 and 1.5 only.

Touch [] to select Shuffle Play mode.

ALL : All songs in the Bluetooth compatible devices are played back in random sequence. Any one song does not play back again until all songs have been played back.

Off : Shuffle mode is Off.

- Operations may differ depending on the connected Bluetooth compatible device.

Connecting a Bluetooth Device

Registering a Bluetooth device in the unit enables automatic connection. If it does not connect automatically, run through the connection procedure again.

Touch [Reconnect] on the Bluetooth Audio screen.

The Bluetooth connection will start.

Disconnecting the Bluetooth Connection

Touch [Disconnect] on the Bluetooth Audio screen.

The Bluetooth connection is disconnected.

Switching the connecting Bluetooth Device

If multiple Bluetooth devices are registered in this device, you can change the connection among the registered devices.

1 Touch [Change Device] on the Bluetooth Audio screen.

2 Touch the device name.

The connection will transfer to the selected device.

Camera Operation (Optional)

When an optional camera is connected, the view video of camera can be output to the monitor.

Rear camera:

If a rear camera is connected, when the vehicle is reversed, the rear camera view (guide marks for vehicle width and available distance) is displayed automatically on the screen of this unit.

You can adjust the quality of the camera image.
Setting items: Brightness / Color / Contrast
See "Camera Picture Quality Setup" (page 16).

Camera Operation

Displaying the Camera Image from the HOME screen

- 1 **Touch the  (HOME) button.**
The HOME screen is displayed.

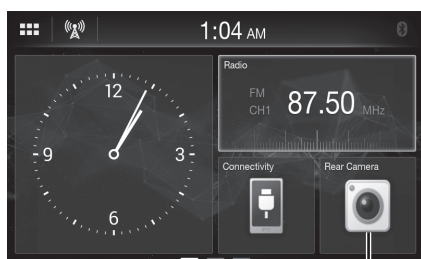

[Rear Camera] button

- If [Camera Select] is set to [Off] (page 15), the [Rear Camera] button cannot be selected.

- 2 **Touch [Rear Camera].**

- Touch [] to return to the main source screen or previous screen.
- You can perform a Guide Adjustment for the rear view image. For details, see "About the Rear Camera Guide" (page 35).

Displaying the rear view video while the car is in reverse

- 1 **Shift the gear lever to the reverse (R) position.**

The rear view image is displayed while the car remains in reverse.

- 2 **If you shift the gear lever to a position other than reverse (R), the monitor returns to the previous screen.**

- Never depend solely on the camera when backing up. Always turn and look and only use the camera for additional assistance.
- This function is effective when the reverse wire is properly connected.
- Touch [] to return to the main source screen or previous screen.
- You can perform a Guide Adjustment for the rear view image. For details, see "About the Rear Camera Guide" (page 35).

About the Rear Camera Guide

To display the guide, set "Turning the Rear Camera Guide On/Off" (page 16) to On. Also, to adjust the guide, see "Rear Camera Guide Settings" (page 16).

■ Indication mark meaning

When the car is put into reverse gear, the monitor switches to the rear view camera image. Guides appear to help visualize the car's width and distance from the rear bumper.

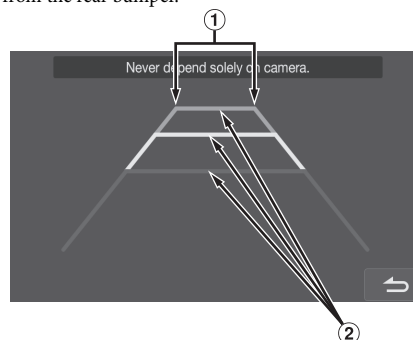

- ① **Car width extension lines (red, yellow and green in order of distance)**

If properly calibrated, the marks indicate the car's width. This helps guide the car's path when backing up in a straight line.

The marks represent the distance from the rear of the car (from the rear end of the bumper).

- The marks do not move in synchronization with the steering wheel.
- Set the marks to suit the car's width.

- ② **Distance guidance lines**

The marks represent the distance from the rear of the car (from the rear end of the bumper).

- The marks do not move in synchronization with the steering wheel.
- We recommend that you measure the actual distance to the marks when parked on a level surface.

- Depending on the condition of the car or road surface, the range of vision may vary.
- The camera has a limited range of vision. Objects at extreme angles to the camera (e.g. under the bumper or at opposite ends of the bumper) may not be in its field-of-vision.
- The rear camera image may have a tint which is different from the actual surroundings.
- Depending on the car, the guidance may deviate to the right or left. This is not a malfunction.

■ **Distance guidance mark**

The distance guides represent the ground level distance from the rear bumper. It is difficult to accurately estimate the distance to objects above ground level.

In the following example, the distance to A is 0.5 m and the distance to B is 1 m.

<Screen>

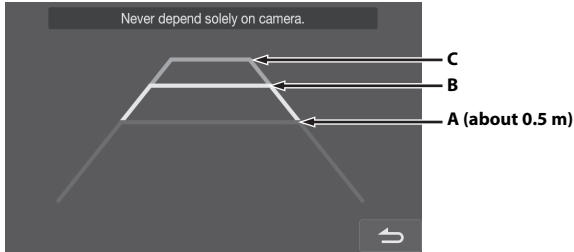

<Positions of A, B and C>

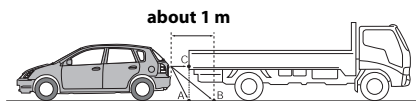

In the screen, according to the distance guidance marks, the truck seems to be parked about 1 m away (at the position B). In actual fact, however, if you reversed to position A, you would collide with the truck. In the screen, positions A, B and C seem to be located in order of proximity. However, in actual fact, the position A and C are the same distance, and B is farther away than positions A and C.

- The car width extension mark represents the distance to the road surface. The distance to an object on the road is not accurately represented by the guides.

Error between the screen and the actual road surface

In the following conditions, errors are produced between the screen guidance and the actual road surface. (The illustrations represent a case when the camera is installed in the standard position.)

■ **When there is a steep upward slope behind the car (example)**

<Screen>

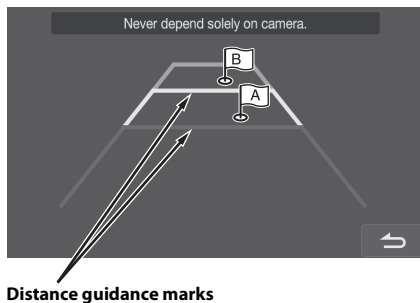

Distance guidance marks

<Situation of the car>

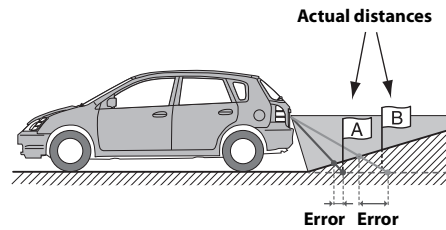

The distance guidance mark represents the distance to a flat road surface. Therefore in the case of an upward slope behind the car, the distance guides are displayed closer to the rear bumper than the actual distance. For example, if there is an obstacle on the upward slope, it may appear farther away than its actual position. Also, an error may occur between the guidance and the actual path of the car on the road surface.

■ **When there is a steep downward slope behind the car (example)**

<Screen>

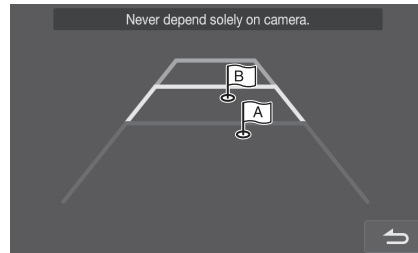

<Situation of the car>

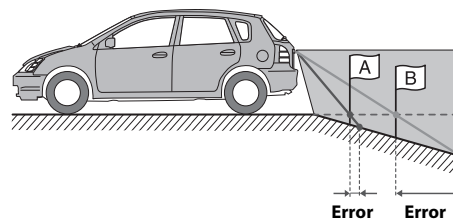

In the case of a downward slope behind the car, the distance guides are displayed farther from the rear bumper than the actual distance. If there is an obstacle on the downward slope, it seems closer than its actual position. Also, an error may occur between the guidance and the actual path of the car on the road surface.

Information

Product Software Update

This product use software that can be updated through a USB flash drive. Download the software from the Alpine website and update the product using the USB flash drive.

Updating this product

Check the Alpine website for details on updating.

<http://www.alpine-usa.com>

Important information on the software

About the software license of the product

The software installed in the product contains open-source software. For details, refer to the "Open source licenses" screen on this unit. See "Displaying Warranty/Copyright Information" (page 13).

About the Supported Formats

About MP3/WMA/AAC/FLAC/WAV



CAUTION

Except for private use, duplicating audio data (including MP3/WMA/AAC/FLAC/WAV data) or distributing, transferring, or copying it, whether for free or for a fee, without permission of the copyright holder is strictly prohibited by the Copyright Act and by international treaty.

What is MP3?

MP3, whose official name is "MPEG Audio Layer 3," is a compression standard prescribed by the ISO, the International Standardization Organization and MPEG which is a joint activity institution of the IEC.

MP3 files contain compressed audio data. MP3 encoding is capable of compressing audio data at extremely high ratios, reducing the size of music files to as much as one-tenth their original size. This is achieved while still maintaining near CD quality. The MP3 format realizes such high compression ratios by eliminating the sounds that are either inaudible to the human ear or masked by other sounds.

What is WMA?

WMA, or "Windows Media™ Audio," is compressed audio data. WMA is similar to MP3 audio data.

What is AAC?

AAC is the abbreviation for "Advanced Audio Coding," and is a basic format of audio compression used by MPEG2 or MPEG4.

What is FLAC?

FLAC (Free Lossless Audio Codec) is an audio file codec for lossless compression, developed and offered as open source software. Codecs with lossy compression forms, such as MP3 and AAC, reduce part of the data to improve compression efficiency. However, FLAC can reconstruct compressed data to be an identical copy of the original data by performing lossless compression. The compression ratio of FLAC is about 50%.

Method for creating MP3/WMA/AAC/FLAC/WAV (USB Flash drive) files

Audio data is compressed using software with MP3/WMA/AAC/FLAC/WAV (USB Flash drive) codecs. For details on creating MP3/WMA/AAC/FLAC/WAV (USB Flash drive) files, refer to the user's manual for that software.

MP3/WMA/AAC/FLAC/WAV (USB Flash drive) files that are playable on this device have the file extensions.

MP3: "mp3"

WMA: "wma"

AAC: "m4a"

FLAC: "flac"/"fla"

WAV: "wav"

WMA is not supported for the following files, Windows Media Audio Professional, Windows Media Audio 10 std or Windows Media Audio 10 Pro Lossless.

There are many different versions of the AAC format. Confirm that the software being used conforms to the acceptable formats listed above. It's possible that the format may be unplayable even though the extension is valid.

Playback of AAC files encoded by iTunes is supported.

Supported playback sampling rates and bit rates

MP3 (USB Flash drive)

Sampling rates: 8 kHz, 11.025 kHz, 12 kHz, 16 kHz, 22.05 kHz, 24 kHz, 32 kHz, 44.1 kHz, 48 kHz

Bit rates: 8 - 320 kbps

WMA (USB Flash drive)

Sampling rates: 8 - 48 kHz

Bit rates: 8 - 384 kbps

AAC (USB Flash drive)

Sampling rates: 8 - 48 kHz

Bit rates: 8 - 384 kbps

FLAC (USB Flash drive)

Sampling rates: 8 - 48 kHz

Bit rates: 8 - 384 kbps

WAV (USB Flash drive)

Sampling rates: 8 - 48 kHz

Bit rates: 64 - 1,536 kbps

This device may not play back correctly depending on sampling rates.

ID3 tags/WMA tags

This device supports ID3 tag v1.0, v1.1, v2.2, v2.3, v2.4, and WMA tag Ver.1.x. If tag data is in an MP3/WMA/AAC file, this device can display the title (track title), artist name, and album name ID3 tag/WMA tag data.

For non-supported characters, "?" is displayed.

The number of characters may be limited, or not correctly displayed, depending on the tag information.

Playing back MP3/WMA/AAC/FLAC/WAV

MP3/WMA/AAC files are prepared, then written to a USB flash drive.

- Maximum numbers of playable files/folders
USB Flash drive: 10,000 files/folders (including Root Folder)
- Largest playable file size: 512 MB

Playback may not be performed if a disc exceeds the limitations described above.

If a file/folder name is long, the maximum possible number of files may decrease.

- Both Audio and Video files are counted if their formats are playable on this unit.

Media supported

The media that this device can play back a USB flash drive.

Corresponding File Systems

This device supports FAT 16/32.

The maximum nested folder depth is 8 (including the root directory). File names are limited to 256 characters (including the extension).

Valid characters for folder/file names are letters A-Z (all caps), numbers 0-9, and '_' (underscore).

Order of files

Files are played back in the order that the writing software writes them to the disc. Therefore, the playback order may not be what's expected. Verify the writing order in the software's documentation. The playback order of the folders and files is as follows. (The following numbers may differ from actually displayed numbers.)

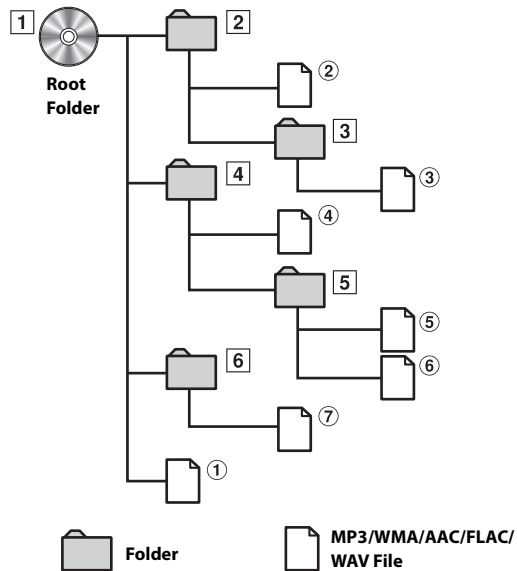

Terminology

Bit rate

This is the "sound" compression rate specified for encoding. The higher the bit rate, the higher the sound quality, but also the larger the files.

Sampling rate

This value shows how many times per second the data is sampled (recorded). For example, music CDs use a sampling rate of 44.1 kHz, so the sound is sampled (recorded) 44,100 times per second. The higher the sampling rate, the higher the sound quality, but also the larger the volume of data.

Encoding

Converting music CDs, WAVE (AIFF) files, and other sound files into the specified audio compression format.

Tag

Song information such as track titles, artist names, album names, etc., written into MP3/WMA/AAC/FLAC/WAV (USB flash drive) files.

Root folder

The root folder (or root directory) is found at the top of the file system. The root folder contains all folders and files. It is created automatically for all burned discs.

In Case of Difficulty

If you encounter a problem, please turn the power off, then on again. If the unit is still not functioning normally, please review the items in the following checklist. This guide will help you isolate the problem if the unit is at fault. Otherwise, make sure the rest of your system is properly connected, or then consult your authorized Alpine dealer.

Basic

No function or display.

- Vehicle's ignition is off.
 - If connected according to the instructions, the unit will not operate with the vehicle's ignition off.
- Improper power lead connections.
 - Check power lead connections.
- Blown fuse.
 - Check the fuse on the battery lead of the unit; replace with the proper value if necessary.
- Internal micro-computer malfunctioned due to interference noise, etc.
 - Press the RESET switch with a ballpoint pen or other pointed article.

No sound or unnatural sound.

- Incorrect setting of volume/balance/fader controls.
 - Readjust the controls.
- Connections are not properly or securely made.
 - Check the connections and firmly connect.

Screen not displayed.

- Brightness/Contrast control is set at the minimum position.
 - Adjust the Brightness/Contrast control.
- Temperature in the vehicle is too low.
 - Increase the vehicle's interior temperature to operation temperature range.
- Connections to the Auxiliary Device are not securely made.
 - Check the connections and firmly connect.
- The Parking Brake Lead is not connected.
- The Parking Brake is not engaged.
 - Connect the Parking Brake Lead, then engage the Parking Brake.

Movement of displayed picture is abnormal.

- Temperature in the vehicle is too high.
 - Allow the vehicle's interior temperature to cool.

Radio

Unable to receive stations.

- No antenna, or open connection in the antenna cable.
 - Make sure the antenna is properly connected; replace the antenna or cable if necessary.

Unable to tune stations in the seek mode.

- You are in a weak signal area.
 - Make sure the tuner is in DX mode.
- If the area you are in is a primary signal area, the antenna may not be grounded and connected properly.
 - Check your antenna connections; make sure the antenna is properly grounded at its mounting location.
- The antenna may not be the proper length.
 - Make sure the antenna is fully extended; if broken, replace the antenna with a new one.

Broadcast is noisy.

- The antenna is not the proper length.
 - Extend the antenna fully; replace it if it is broken.
- The antenna is poorly grounded.
 - Make sure the antenna is grounded properly at its mounting location.
- The station signal is weak and noisy.
 - If above solution does not work, tune in another station.

USB Audio

Unit does not operate.

- Condensation.
 - Wait a while (about 1 hour) for the condensation to dry.

Picture is unclear or noisy.

- Vehicle's battery power is weak.
 - Check the battery power and wiring.
(The unit may malfunction if the battery power is under 11 volts with a load applied.)

If this Message Appears

Various messages are displayed on the screen during operation. In addition to the messages telling you the current status or providing guidance for the next operation, there are also the following error messages. If one of these error messages is displayed, carefully follow the instructions in the solution column.

System

This operation is prohibited for your safety.

- A setup operation, etc., was carried out while the vehicle was running.
 - Move the vehicle to a safe location, stop, and engage the parking brake, then carry out this operation.
-

Unsupported USB device connected.

- A USB flash drive with a hub is connected.
 - You cannot play back from a USB flash drive with a hub. USB hub connections are also not supported.
-

Audio/Visual

Unsupported USB device connected.

- An iPhone that is not supported by the unit is connected.
 - Connect an iPhone that is supported by the unit.
 - A USB device that is not supported by the unit is connected.
 - Attempt to connect another USB flash drive.
 - Communication error.
 - Turn the ignition key off, and then set to ON again.
 - Check the display by reconnecting between the iPhone and the unit, using the iPhone cable.
 - Check the display by reconnecting between the USB flash drive and the unit.
 - Caused by the iPod/iPhone Software Version not being compatible with this unit.
 - Update the iPhone Software Version to be compatible with this unit.
 - The iPhone is not verified.
 - Change to another iPhone.
-

No Song

- There are no data in the iPhone.
 - Download data to the iPhone and connect to the unit.
-

No File

- There are no data in the USB flash drive.
 - Download data to the USB flash drive and connect to this unit.
-

File format not supported.

- A copy-protected WMA file has been detected.
 - You can only play back non-copy-protected files.
 - A sampling rate/bit rate not supported by the unit is used.
 - Use a sampling rate/bit rate supported by the unit.
-

Bluetooth

No Bluetooth

- The Bluetooth audio device was not connected correctly.
 - Check the settings for the unit and the Bluetooth audio device and reconnect.
-

Specifications

MONITOR SECTION

Screen Size	9"
LCD Type	Transparent type TN LCD
Operation System	TFT active matrix
Number of Picture Elements	1,152,000 pcs. (800 × 480 × 3 (RGB))
Effective Number of Picture Elements	99% or more
Illumination System	LED

FM TUNER SECTION

Tuning Range	87.5 – 108.0 MHz
Mono Usable Sensitivity	9.3 dBf (0.8 μV/75 ohms)
50 dB Quieting Sensitivity	13.5 dBf (1.3 μV/75 ohms)
Alternate Channel Selectivity	80 dB
Signal-to-Noise Ratio	65 dB
Stereo Separation	35 dB
Capture Ratio	2.0 dB

AM TUNER SECTION

Tuning Range	531 – 1,602 kHz
Usable Sensitivity	25.1 μV/28 dBf

USB SECTION

USB requirements	USB 2.0
Max. Power Consumption	1,500 mA (CDP Support)
USB Class	USB (Play From Device)/ USB (Mass Storage Class)
File System	FAT16/32
Number of Channels	2-Channels (Stereo)
Frequency Response*1	5 – 20,000 Hz (±1 dB)
Total Harmonic Distortion	0.008% (at 1 kHz)
Dynamic Range	95 dB (at 1 kHz)
Signal-to-Noise Ratio	100 dB
Channel Separation	85 dB (at 1 kHz)

*1 Frequency response may differ depending on the encoder software/bit rate.

Bluetooth SECTION

Bluetooth Specification	Bluetooth V4.1
Output Power	+4 dBm Ave. (Power class 2)
Profile	HFP (Hands-Free Profile) PBAP (Phone Book Access Profile) A2DP (Advanced Audio Distribution Profile) AVRCP (Audio/Video Remote Control Profile)

GENERAL

Power Requirement	14.4 V DC (11–16 V allowable)
Operating temperature	-20°C to + 60°C
Power Output	16 W RMS × 4*2
*2 Primary amplifier ratings per CEA-2006 Standard	
• Power output: measured at 4 Ohms and ≤ 1% THD+N	
• S/N: 80 dBA (reference: 1 W into 4 Ohms)	
Weight	2.56 kg
Audio output level	
Preout (Front, Rear):	4V/10k ohms (max.)
Preout (Subwoofer):	4V/10k ohms (max.)

CHASSIS SIZE

Width	178 mm
Height	50 mm
Depth	160 mm

- Due to continuous product improvement, specifications and design are subject to change without notice.
- The LCD panel is manufactured using an extremely high precision manufacturing technology. Its effective pixel ratio is over 99.99%. This means that there is a possibility that 0.01% of the pixels could be either always ON or OFF.

