



CD/USB RECEIVER WITH ADVANCED BLUETOOTH

CDE-173EBT

CD/USB RECEIVER

CDE-170E

DIGITAL MEDIA RECEIVER WITH ADVANCED BLUETOOTH

UTE-73EBT

• **OWNER'S MANUAL**

Please read before using this equipment.

Printed in Thailand
68-40368Z02-C (Y-D)



* 6 8 4 0 3 6 8 Z 0 2 C *



Made for
 iPhone | iPod



(CDE-173EBT/ UTE-73EBT)

(CDE-173EBT/ UTE-73EBT)

(CDE-173EBT/ CDE-170E)

ALPINE ELECTRONICS MARKETING, INC.

1-7, Yukigaya-Otsukamachi, Ota-ku,
Tokyo 145-0067, JAPAN
Phone: 03-5499-4531

ALPINE ELECTRONICS OF AMERICA, INC.

19145 Gramercy Place, Torrance,
California 90501, U.S.A.
Phone 1-800-ALPINE-1 (1-800-257-4631)

ALPINE ELECTRONICS OF AUSTRALIA PTY. LTD.

161-165 Princes Highway, Hallam
Victoria 3803, Australia
Phone 03-8787-1200

ALPINE ELECTRONICS GmbH

Wilhelm-Wagenfeld-Str. 1-3,
80807 München, Germany
Phone 089-32 42 640

ALPINE ELECTRONICS OF U.K. LTD.

Alpine House
Fletchamstead Highway, Coventry CV4 9TW, U.K.
www.alpine.co.uk

ALPINE ELECTRONICS France S.A.R.L.

184 allée des Erables
CS 52016 – Villepinte
95 945 Roissy CDG cedex
FRANCE

Phone : + 33(0)1 48 63 89 89

ALPINE ITALIA S.p.A.

Viale Cristoforo Colombo, 8
20090 Trezzano sul Naviglio MI, Italy
Phone +39 02 484781

ALPINE ELECTRONICS DE ESPAÑA, S.A.

Portal de Gamarra 36, Pabellón, 32
01013 Vitoria (Alava)-APDO 133, Spain
Phone 945-283588

For safety, be sure to install this unit in the dashboard of the car as the rear side of the unit becomes hot during use.
For details, see "Connection/Installation" (page 30).

Warning if your car's ignition has no ACC position

Be sure to set the AUTO OFF function (page 19). The unit will shut off completely and automatically in the set time after the unit is turned off, which prevents battery drain. If you do not set the AUTO OFF function, press and hold  (power) until the display disappears each time you turn the ignition off.

Disclaimer regarding services offered by third parties

Services offered by third parties may be changed, suspended, or terminated without prior notice. Alpine does not bear any responsibility in these sorts of situations.

Important notice

Caution

IN NO EVENT SHALL ALPINE BE LIABLE FOR ANY INCIDENTAL, INDIRECT OR CONSEQUENTIAL DAMAGES OR OTHER DAMAGES INCLUDING, WITHOUT LIMITATION, LOSS OF PROFITS, LOSS OF REVENUE, LOSS OF DATA, LOSS OF USE OF THE PRODUCT OR ANY ASSOCIATED EQUIPMENT, DOWNTIME, AND PURCHASER'S TIME RELATED TO OR ARISING OUT OF THE USE OF THIS PRODUCT, ITS HARDWARE AND/OR ITS SOFTWARE.

IMPORTANT

Please record the serial number of your unit in the space provided below and keep it as a permanent record.

SERIAL NUMBER: _____

INSTALLATION DATE: _____

INSTALLATION TECHNICIAN: _____

PLACE OF PURCHASE: _____

Dear customer, this product includes a radio transmitter.

Please check your vehicle operation manual or contact the manufacturer of your vehicle or your vehicle dealer, before you install this product into your vehicle.

Emergency calls

This BLUETOOTH car handsfree and the electronic device connected to the handsfree operate using radio signals, cellular, and landline networks as well as user-programmed function, which cannot guarantee connection under all conditions.

Therefore do not rely solely upon any electronic device for essential communications (such as medical emergencies).

On BLUETOOTH communication

- Microwaves emitting from a BLUETOOTH device may affect the operation of electronic medical devices. Turn off this unit and other BLUETOOTH devices in the following locations, as it may cause an accident.
 - where inflammable gas is present, in a hospital, train, airplane, or petrol station
 - near automatic doors or a fire alarm
- This unit supports security capabilities that comply with the BLUETOOTH standard to provide a secure connection when the BLUETOOTH wireless technology is used, but security may not be enough depending on the setting. Be careful when communicating using BLUETOOTH wireless technology.
- We do not take any responsibility for the leakage of information during BLUETOOTH communication.

If you have any questions or problems concerning your unit that are not covered in this manual, consult your nearest Alpine dealer.

WARNING



WARNING

This symbol means important instructions. Failure to heed them can result in serious injury or death.

DO NOT OPERATE ANY FUNCTION THAT TAKES YOUR ATTENTION AWAY FROM SAFELY DRIVING YOUR VEHICLE.

Any function that requires your prolonged attention should only be performed after coming to a complete stop. Always stop the vehicle in a safe location before performing these functions. Failure to do so may result in an accident.

KEEP THE VOLUME AT A LEVEL WHERE YOU CAN STILL HEAR OUTSIDE NOISES WHILE DRIVING.

Excessive volume levels that obscure sounds such as emergency vehicle sirens or road warning signals (train crossings, etc.) can be dangerous and may result in an accident. LISTENING AT LOUD VOLUME LEVELS IN A CAR MAY ALSO CAUSE HEARING DAMAGE.

DO NOT DISASSEMBLE OR ALTER.

Doing so may result in an accident, fire or electric shock.

USE ONLY IN CARS WITH A 12 VOLT NEGATIVE GROUND.

(Check with your dealer if you are not sure.) Failure to do so may result in fire, etc.

KEEP SMALL OBJECTS SUCH AS BATTERIES OUT OF THE REACH OF CHILDREN.

Swallowing them may result in serious injury. If swallowed, consult a physician immediately.

USE THE CORRECT AMPERE RATING WHEN REPLACING FUSES.

Failure to do so may result in fire or electric shock.

DO NOT BLOCK VENTS OR RADIATOR PANELS.

Doing so may cause heat to build up inside and may result in fire.

USE THIS PRODUCT FOR MOBILE 12V APPLICATIONS.

Use for other than its designed application may result in fire, electric shock or other injury.

DO NOT PLACE HANDS, FINGERS OR FOREIGN OBJECTS IN INSERTION SLOTS OR GAPS.

Doing so may result in personal injury or damage to the product.

MAKE THE CORRECT CONNECTIONS.

Failure to make the proper connections may result in fire or product damage.

BEFORE WIRING, DISCONNECT THE CABLE FROM THE NEGATIVE BATTERY TERMINAL.

Failure to do so may result in electric shock or injury due to electrical shorts.

DO NOT SPLICE INTO ELECTRICAL CABLES.

Never cut away cable insulation to supply power to other equipment. Doing so will exceed the current carrying capacity of the wire and result in fire or electric shock.

DO NOT DAMAGE PIPE OR WIRING WHEN DRILLING HOLES.

When drilling holes in the chassis for installation, take precautions so as not to contact, damage or obstruct pipes, fuel lines, tanks or electrical wiring. Failure to take such precautions may result in fire.

DO NOT USE BOLTS OR NUTS IN THE BRAKE OR STEERING SYSTEMS TO MAKE GROUND CONNECTIONS.

Bolts or nuts used for the brake or steering systems (or any other safety-related system), or tanks should NEVER be used for installations or ground connections. Using such parts could disable control of the vehicle and cause fire etc.

DO NOT INSTALL IN LOCATIONS WHICH MIGHT HINDER VEHICLE OPERATION, SUCH AS THE STEERING WHEEL OR SHIFT LEVER.

Doing so may obstruct forward vision or hamper movement etc. and results in serious accident.

DO NOT INSTALL IN LOCATIONS WITH HIGH MOISTURE OR DUST.

Avoid installing the unit in locations with high incidence of moisture or dust. Moisture or dust that penetrates into this unit may result in product failure.



CAUTION

This symbol means important instructions. Failure to heed them can result in injury or material property damage.

HALT USE IMMEDIATELY IF A PROBLEM APPEARS.

Failure to do so may cause personal injury or damage to the product. Return it to your authorized Alpine dealer or the nearest Alpine Service Centre for repairing.

HAVE THE WIRING AND INSTALLATION DONE BY EXPERTS.

The wiring and installation of this unit requires special technical skill and experience. To ensure safety, always contact the dealer where you purchased this product to have the work done.

USE SPECIFIED ACCESSORY PARTS AND INSTALL THEM SECURELY.

Be sure to use only the specified accessory parts. Use of other than designated parts may damage this unit internally or may not securely install the unit in place. This may cause parts to become loose resulting in hazards or product failure.

ARRANGE THE WIRING SO IT IS NOT CRIMPED OR PINCHED BY A SHARP METAL EDGE.

Route the cables and wiring away from moving parts (like the seat rails) or sharp or pointed edges. This will prevent crimping and damage to the wiring. If wiring passes through a hole in metal, use a rubber grommet to prevent the wire's insulation from being cut by the metal edge of the hole.

Table of Contents

WARNING	3
Guide to Parts and Controls	6

Getting Started

Detaching the Front Panel	8
Resetting the Unit	8
Switching the FM Tuning Step	8
Setting the Clock	8
Preparing a BLUETOOTH Device (CDE-173EBT/ UTE-73EBT only)	9
Connecting a USB Device	11
Connecting Other Portable Audio Device	11

Listening to the Radio

Listening to the Radio	11
Using Radio Data System (RDS)	12

Playback

Playing a Disc (CDE-173EBT/ CDE-170E only) ...	13
Playing a USB Device	13
Playing a BLUETOOTH Device (CDE-173EBT/ UTE-73EBT only)	13
Searching and Playing Tracks	14

Handsfree Calling (via BLUETOOTH only) (CDE-173EBT/ UTE-73EBT only)

Receiving a Call	15
Making a Call	15
Available Operations during Call	16

Useful Functions

Adjusting Bass Level/ Mid Level/ Treble Level/ Subwoofer Level/ Balance (Between Left and Right)/ Fader (Between Front and Rear)	17
Setting the BASS ENGINE SQ	17
Using Siri Eyes Free (CDE-173EBT/ UTE-73EBT only)	17

Settings

Canceling the DEMO Mode	19
Basic Setting Operation	19
General Setup (GENERAL)	19
Audio Setup (AUDIO)	20
Display Setup (DISPLAY)	20
BLUETOOTH Setup (BLUETOOTH) (CDE-173EBT/ UTE-73EBT only)	21

Additional Information

Updating the Firmware	22
Precautions	22
Maintenance	23
Specifications	23
Troubleshooting	26
Messages	29

Connection/Installation

Cautions	30
Parts List for Installation	30
Connection	31
Installation	34

Guide to Parts and Controls

Main unit

■ CDE-173EBT/ UTE-73EBT

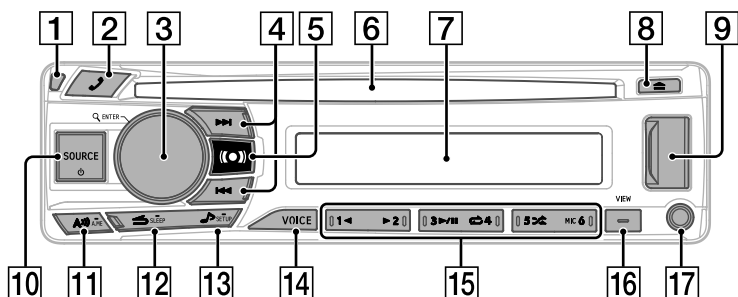

■ CDE-170E

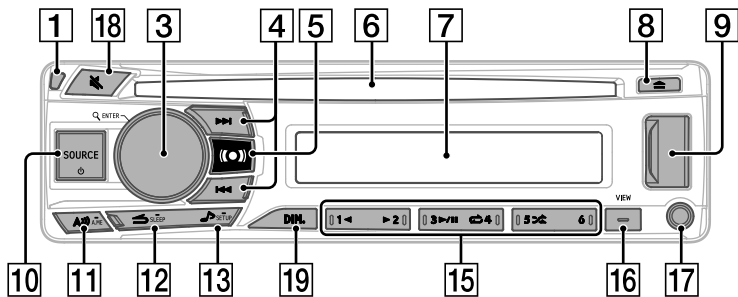

1 Front panel release button



2 Enter the call menu. Receive/end a call. Press and hold for more than 2 seconds to switch the BLUETOOTH signal.

3 Control dial

Rotate to adjust the volume.

ENTER

Enter the selected item.

Q (browse) (pages 12, 14)

Enter the browse mode during playback. (Not available when a USB device in Android mode or iPod is connected.)

Select PTY in RDS.



Radio mode:

Tune in radio stations automatically. Press and hold to tune manually.

Disc/USB Device mode:

Switch between previous/next song.

Press and hold for 2 seconds to fast-reverse/ fast-forward.

5  (page 17)

6 **Disc slot (CDE-173EBT/ CDE-170E only)**

7 **Display window**

8  **(disc eject) (CDE-173EBT/ CDE-170E only)**

9 **USB port**

10 **SOURCE**

Change the source.

 **(power)**

Turn on the power.

Press and hold for more than 2 seconds to turn off the power and the display.

11  **(A))**

Press in the Radio mode to change the radio band.

 **A.M.E**

Press and hold for more than 2 seconds in the Radio mode to store stations automatically.

12  **(back)**

Return to the previous display.

 **SLEEP**

Press and hold for 2 seconds to turn the source off and display the clock.

13  **(page 17)**

Open audio setup mode directly.

 **SETUP**

Press and hold to open the setup menu.

14 **VOICE (pages 16, 17)**

Press to activate voice dial, voice recognition (Android™ smartphone only), or the Siri function (iPhone only).

15 **Number buttons (1 to 6)**

Receive stored radio stations. Press and hold to store stations.

 

Skip an album for audio device. Press and hold to skip albums continuously.
(Not available when a USB device in Android mode or iPod is connected.)

 **(play/pause)**

 **(repeat)**

(Not available when a USB device in Android mode is connected.)

 **(shuffle)**

(Not available when a USB device in Android mode is connected.)

MIC (CDE-173EBT/ UTE-73EBT only) (page 16)

16 **VIEW**

Change display items.

 **(scroll)**

Press and hold to scroll a display item.

17 **AUX input jack**

18  **(MUTE)**

Set the mute mode to on/off.

19 **DIM.**

Press to change the Dimmer function.

Controllable with Remote Control

This unit can be controlled with an optional Alpine remote control. For details, consult your Alpine dealer.

Point the optional remote control transmitter at the remote control sensor.

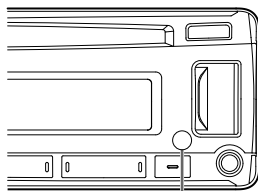

Remote control sensor

Connectable to Remote Control Interface Box

With an optional Alpine Steering Wheel Remote Control Interface Box (not included), this unit is controllable from the vehicles steering wheel controls. For details, contact your Alpine dealer.

Getting Started

To cancel the demonstration (DEMO) display, see page 19.

For the connection/installation, see page 30.

Detaching the Front Panel

You can detach the front panel of this unit to prevent theft.

- 1 Press and hold  (power) ① until the unit turns off, press the front panel release button ②, then pull the panel towards you to remove.

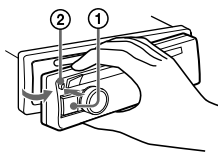

Caution alarm

If you turn the ignition switch to the OFF position without detaching the front panel, the caution alarm will sound for a few seconds. The alarm will only sound if the built-in amplifier is used.

Attaching the front panel

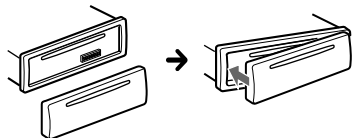

Resetting the Unit

Before operating the unit for the first time, or after replacing the car battery or changing connections, you must reset the unit.

- 1 Press  and Number button 6 for more than 2 seconds.



Note

Resetting the unit will erase the clock setting and some stored contents.



Switching the FM Tuning Step

Set the FM tuning step of your country.

This setting appears only while the source is off and the clock is displayed.

- 1 Press and hold  /SETUP for at least 2 seconds, rotate the control dial to select [GENERAL], then press it.
- 2 Rotate the control dial to select [FM STEP], then press it.
- 3 Rotate the control dial to select from [FM STEP 50K] or [FM STEP 100K], then press it.
- 4 Press  (back) twice.
The setup is complete.

Setting the Clock

- 1 Press and hold  /SETUP for at least 2 seconds, rotate the control dial to select [GENERAL], then press it.
- 2 Rotate the control dial to select [CLOCK ADJ], then press it.
The hour indication flashes.
- 3 Rotate the control dial to adjust the hour and minute.
To move the digital indication, press  / .
- 4 Press ENTER to set the hour and minute.

- 5 Press  (back) twice.
The setup is complete.

To display the clock

Press VIEW.

Preparing a BLUETOOTH Device (CDE-173EBT/ UTE-73EBT only)



You can enjoy music, or perform handsfree calling depending on the BLUETOOTH compatible device such as a smartphone, cellular phone and audio device (hereafter "BLUETOOTH device" if not otherwise specified). For details on connecting, refer to the operating instructions supplied with the device.

Before connecting the device, turn down the volume of this unit; otherwise, loud sound may result.

Pairing and connecting with a BLUETOOTH device

When connecting a BLUETOOTH device for the first time, mutual registration (called "pairing") is required. Pairing enables this unit and other devices to recognize each other. This unit can connect two BLUETOOTH devices (two cellular phones, or a cellular phone and an audio device).



- 1 Place the BLUETOOTH device within 1 m (3 ft) of this unit.
- 2 Press and hold /SETUP for at least 2 seconds, rotate the control dial to select [BLUETOOTH], then press it.
- 3 Rotate the control dial to select [PAIRING], then press it.
- 4 Rotate the control dial to select [SET DEVICE 1]* or [SET DEVICE 2]*, then press it.
 flashes while the unit is in pairing standby mode.

* [SET DEVICE 1] or [SET DEVICE 2] will be changed to the paired device name after pairing is complete.

- 5 Perform pairing on the BLUETOOTH device so it detects this unit.
- 6 Select [CDE-173EBT] [UTE-73EBT] (your model name) shown in the display of the BLUETOOTH device.
If your model name does not appear, repeat from step 2.



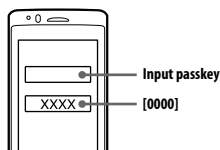

- 7 If passkey* input is required on the BLUETOOTH device, input [0000].

* Passkey may be called "Passcode," "PIN code," "PIN number" or "Password," etc., depending on the device.



When pairing is made,  stays lit.

- 8 Select this unit on the BLUETOOTH device to establish the BLUETOOTH connection.
 or  lights up when the connection is made.

Note

While connecting to a BLUETOOTH device, this unit cannot be detected from another device. To enable detection, enter the pairing mode and search for this unit from another device.

To start playback

For details, see "Playing a BLUETOOTH Device (CDE-173EBT/ UTE-73EBT only)" (page 13).

To disconnect the paired device

Perform steps 2 to 4 to disconnect after this unit and the BLUETOOTH device are paired.

Connecting with a paired BLUETOOTH device

To use a paired device, connection with this unit is required. Some paired devices will connect automatically.



- 1 Press and hold **🔊/SETUP** for at least 2 seconds, rotate the control dial to select [BLUETOOTH], then press it.
- 2 Rotate the control dial to select [BT IN], then press it.
Make sure that **📶** lights up.
- 3 Activate the BLUETOOTH function on the BLUETOOTH device.
- 4 Operate the BLUETOOTH device to connect to this unit.
📶 or **📶** lights up.

Icons in the display:

	Lights up when handsfree calling is available by enabling the HFP (Handsfree Profile).
	Lights up when the audio device is playable by enabling the A2DP (Advanced Audio Distribution Profile).

To connect the last-connected device from this unit

Activate the BLUETOOTH function on the BLUETOOTH device.

To connect with the audio device, press **SOURCE** **🔊** to select [BT AUDIO].

To connect with the cellular phone, press **🔊**.

Note

While streaming BLUETOOTH audio, you cannot connect from this unit to the cellular phone. Connect from the cellular phone to this unit instead.

Tip

With BLUETOOTH signal on: when the ignition is turned on, this unit reconnects automatically to the last-connected cellular phone.

To install the microphone

For details, see "Installing the microphone (CDE-173EBT/ UTE-73EBT only)" (page 34).

Connecting with an iPhone/iPod (BLUETOOTH Auto Pairing)

When an iPhone/iPod with iOS5 or later installed is connected to the USB port, the unit is paired and connected with the iPhone/iPod automatically.

To enable BLUETOOTH Auto Pairing, make sure [AUTO PAIR] in [BLUETOOTH] is set to [ON] (page 21).

- 1 Activate the BLUETOOTH function on the iPhone/iPod.
- 2 Connect an iPhone/iPod to the USB port.

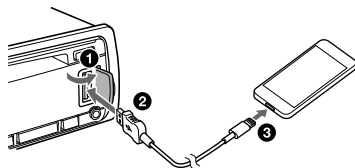

Make sure that **📶** lights up on the display of the unit.

Notes

- BLUETOOTH Auto Pairing is not possible if the unit is already connected to two BLUETOOTH devices. In this case, disconnect either device, then connect the iPhone/iPod again.
- If BLUETOOTH Auto Pairing is not established, see "Preparing a BLUETOOTH Device (CDE-173EBT/ UTE-73EBT only)" (page 9).

Connecting a USB Device

- 1 Turn down the volume on the unit.
- 2 Connect the USB device to the unit.
To connect an iPod/iPhone, use the USB connection cable for iPod (not supplied). (CDE-173EBT/UTE-73EBT only)

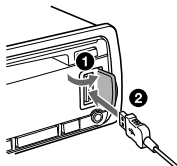

Connecting Other Portable Audio Device

- 1 Turn off the portable audio device.
- 2 Turn down the volume on the unit.
- 3 Connect the portable audio device to the AUX input jack (stereo mini jack) on the unit with a connecting cord (not supplied)*.

* Be sure to use a straight type plug.

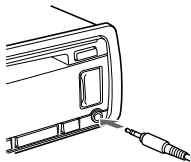

- 4 Press SOURCE \odot to select [AUX].

To match the volume level of the connected device to other sources

Start playback of the portable audio device at a moderate volume, and set your usual listening volume on the unit.

Press and hold \blacktriangleright /SETUP for at least 2 seconds, then select [AUDIO] \rightarrow [AUX VOL] (page 20).

Listening to the Radio

Listening to the Radio

To listen to the radio, press SOURCE \odot to select [TUNER].

Storing automatically

- 1 Press \blacktriangleleft)/A.ME to change the band (FM1, FM2, FM3, AM1 or AM2).
- 2 Press and hold \blacktriangleleft)/A.ME for at least 2 seconds.
The unit stores stations in order of frequency on the number buttons.

Tuning

- 1 Press \blacktriangleleft)/A.ME to change the band (FM1, FM2, FM3, AM1 or AM2).
- 2 Perform tuning.
To tune manually
Press and hold \blacktriangleleft / \blacktriangleright to locate the approximate frequency, then press \blacktriangleleft / \blacktriangleright repeatedly to finely adjust to the desired frequency.

To tune automatically

Press \blacktriangleleft / \blacktriangleright .

Scanning stops when the unit receives a station.

Storing manually

- 1 While receiving the station that you want to store, press and hold a number button (1 to 6) until [MEM] appears.

Receiving the stored stations

- 1 Select the band, then press a number button (1 to 6).

Using Radio Data System (RDS)

Selecting program types (PTY)

- 1 Press  (browse) during FM reception.
- 2 Rotate the control dial until the desired program type appears, then press it.
The unit starts to search for a station broadcasting the selected program type.

Type of programs

NEWS (News), **AFFAIRS** (Current Affairs), **INFO** (Information), **SPORT** (Sports), **EDUCATE** (Education), **DRAMA** (Drama), **CULTURE** (Culture), **SCIENCE** (Science), **VARIED** (Varied), **POP M** (Pop Music), **ROCK M** (Rock Music), **EASY M** (M.O.R. Music), **LIGHT M** (Light classical), **CLASSICS** (Serious classical), **OTHER M** (Other Music), **WEATHER** (Weather), **FINANCE** (Finance), **CHILDREN** (Children's program), **SOCIAL A** (Social Affairs), **RELIGION** (Religion), **PHONE IN** (Phone In), **TRAVEL** (Travel), **LEISURE** (Leisure), **JAZZ** (Jazz Music), **COUNTRY** (Country Music), **NATION M** (National Music), **OLDIES** (Oldies Music), **FOLK M** (Folk Music), **DOCUMENT** (Documentary)

Setting clock time (RDS CT)

The CT data from the RDS transmission sets the clock.

- 1 Set [RDS CT ON] in [GENERAL] (page 19).

Playback

Playing a Disc (CDE-173EBT/ CDE-170E only)

1 Insert the disc (label side up).

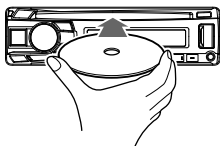

Playback starts automatically.

Playing a USB Device

In these Operating Instructions, "iPod" is used as a general reference for the iPod functions on an iPod and iPhone, unless otherwise specified by the text or illustrations. (iPod/iPhone operation is available on CDE-173EBT/ UTE-73EBT only.)

For details on the compatibility of your iPod, see "About iPod (CDE-173EBT/ UTE-73EBT only)" (page 23).

AOA (Android Open Accessory) 2.0, MSC (Mass Storage Class) and MTP (Media Transfer Protocol) type USB devices* compliant with the USB standard can be used. Depending on the USB device, the Android mode or MSC/MTP mode can be selected on the unit.

Some digital media players or Android smartphones may require setting to MTP mode.

* e.g., a USB flash drive, digital media player, Android smartphone

Notes

- For details on the compatibility of your USB device, consult your nearest Alpine dealer.
- Smartphones with Android OS 4.1 or higher installed support Android Open Accessory 2.0 (AOA 2.0). However, some smartphones may not fully support AOA 2.0 even if Android OS 4.1 or higher is installed. For details on the compatibility of your Android smartphone, consult your nearest Alpine dealer.

- Playback of the following files is not supported.
MP3/WMA/FLAC/AAC*:
 - copyright-protected files
 - DRM (Digital Rights Management) files
 - Multi-channel audio filesMP3/WMA/AAC*:
 - lossless compression files

* CDE-173EBT/ UTE-73EBT only

Before making a connection, select the USB mode (Android mode or MSC/MTP mode) depending on the USB device (page 19).

1 Connect a USB device to the USB port (page 11).

Playback starts.

If a device is already connected, to start playback, press SOURCE  to select [USB] ([IPD] appears in the display when the iPod is recognized).

2 Adjust the volume on this unit.

To stop playback

Press and hold SLEEP for 2 seconds.

To remove the device

Stop playback, then remove the device.

Caution for iPhone

When you connect an iPhone via USB, phone call volume is controlled by the iPhone, not the unit. Do not inadvertently increase the volume on the unit during a call, as a sudden loud sound may result when the call ends.

Playing a BLUETOOTH Device (CDE-173EBT/ UTE-73EBT only)

You can play contents on a connected device that supports BLUETOOTH A2DP (Advanced Audio Distribution Profile).



1 Make BLUETOOTH connection with the audio device (page 9).

To select the audio device, press and hold /SETUP for at least 2 seconds, then select [BLUETOOTH] → [AUDIO DEVICE] (page 21).

2 Press SOURCE  to select [BT AUDIO].

3 Operate the audio device to start playback.

4 Adjust the volume on this unit.

Notes

- Depending on the audio device, information such as title, track number/time and playback status may not be displayed on this unit.
- Even if the source is changed on this unit, playback of the audio device does not stop.

To match the volume level of the BLUETOOTH device to other sources



Start playback of the BLUETOOTH audio device at a moderate volume, and set your usual listening volume on the unit.

Press and hold /SETUP for at least 2 seconds, then select [AUDIO] → [BTA VOL] (page 20).

Searching and Playing Tracks

Repeat play and shuffle play

Not available when a USB device in Android mode is connected.

1 During playback, press  (repeat) or  (shuffle) repeatedly to select the desired play mode.

Playback in the selected play mode may take time to start.

Available play modes differ depending on the selected sound source.

Searching a track by name

Not available when a USB device in Android mode or iPod is connected.

1 During CD or USB playback, press  (browse) to display the list of search categories.

When the track list appears, press  (back) repeatedly to display the desired search category.

2 Rotate the control dial to select the desired search category, then press it to confirm.

3 Repeat step 2 to search the desired track. Playback starts.

Searching by skipping items (Jump mode)

Not available when a USB device in Android mode or iPod is connected.

1 Press  (browse).

2 Press .

3 Rotate the control dial to select the item. The list is jumped in steps of 10% of the total number of items.

4 Press ENTER to return to the browse mode. The selected item appears.

5 Rotate the control dial to select the desired item, then press it. Playback starts.

Handsfree Calling (via BLUETOOTH only) (CDE-173EBT/UTE-73EBT only)

To use a cellular phone, connect it with this unit. You can connect two cellular phones to the unit. For details, see "Preparing a BLUETOOTH Device (CDE-173EBT/ UTE-73EBT only)" (page 9).



Receiving a Call

- 1 Press when a call is received with a ringtone.

The phone call starts.

Note

The ringtone and talker's voice are output only from the front speakers.

To reject the call

Press and hold SLEEP for 2 seconds.

To end the call

Press again.

Making a Call

You can make a call from the phonebook or call history when a cellular phone supporting PBAP (Phone Book Access Profile) is connected.

When two cellular phones are connected to the unit, select either phone.

From the phonebook

- 1 Press .

When two cellular phones are connected to the unit, rotate the control dial to select either phone, then press it.

- 2 Rotate the control dial to select [PHONE BOOK], then press it.
- 3 Rotate the control dial to select an initial from the initial list, then press it.
- 4 Rotate the control dial to select a name from the name list, then press it.
- 5 Rotate the control dial to select a number from the number list, then press it.

The phone call starts.

From the call history

- 1 Press .
- 2 Rotate the control dial to select [HISTORY], then press it.
A list of the call history appears.
- 3 Rotate the control dial to select a name or phone number from the call history, then press it.
The phone call starts.

By phone number input

- 1 Press .
 - 2 Rotate the control dial to select [DIAL NUMBER], then press it.
 - 3 Rotate the control dial to enter the phone number, and lastly select [] (space), then press ENTER*.
- The phone call starts.

* To move the digital indication, press / .

Note

[] appears instead of [#] on the display.

By redial

- 1 Press .**
When two cellular phones are connected to the unit, rotate the control dial to select either phone, then press it.
- 2 Rotate the control dial to select [REDIAL], then press it.**
The phone call starts.

By voice tags

You can make a call by saying the voice tag stored in a connected cellular phone that has a voice dialing function.

- 1 Press .**
When two cellular phones are connected to the unit, rotate the control dial to select either phone, then press it.
- 2 Rotate the control dial to select [VOICE DIAL], then press it.**
Alternatively, press VOICE.
- 3 Say the voice tag stored on the cellular phone.**
Your voice is recognized, and the call is made.

To cancel voice dialing

Press VOICE.

Available Operations during Call

To adjust the ringtone volume

Rotate the control dial while receiving a call.

To adjust the talker's voice volume

Rotate the control dial during a call.

To adjust the volume for the other party (Mic gain adjustment)

Press MIC.

Adjustable volume levels: [MIC GAIN LOW], [MIC GAIN MID], [MIC GAIN HI].

To reduce echo and noise (Echo Canceler/ Noise Canceler Mode)

Press and hold MIC.

Settable mode: [BTP EC/NC 1], [BTP EC/NC 2].

To switch between handsfree mode and handheld mode

During a call, press /A.ME to switch the phone call audio between the unit and cellular phone.

Note

Depending on the cellular phone, this operation may not be available.

Useful Functions

Adjusting Bass Level/ Mid Level/ Treble Level/ Subwoofer Level/ Balance (Between Left and Right)/ Fader (Between Front and Rear)

- 1 Press /SETUP.
- 2 Rotate the control dial to adjust the each mode, then press it.

Each press changes the mode as follows:
BASS → MID → TREBLE → SUBW → BALANCE → FADER

Bass Level	-7 to +7
Mid Level	-7 to +7
Treble Level	-7 to +7
Subwoofer Level	OFF to 0 to +15
Balance	L15 to R15
Fader	R15 to F15

- 3 Press /SETUP to return the normal mode.

Notes

- If no operation is performed for 5 seconds, the unit automatically returns to normal mode.
- When Bass/Mid/Treble/Subwoofer Level is adjusted, BASS ENGINE SQ is set to [OFF] (page 17).

Setting the BASS ENGINE SQ

Creating the ideal Bass impact for your musical taste using BASS ENGINE SQ.

- 1 Press .
- 2 Rotate the control dial to adjust [BASS ENG], then press it.

Setting contents: [OFF], [1]-[6]

Note

When Bass/Mid/Treble/Subwoofer Level is adjusted, BASS ENGINE SQ is set to [OFF] (page 17).

Using Siri Eyes Free (CDE-173EBT/ UTE-73EBT only)

Siri Eyes Free allows you to use an iPhone handsfree by simply speaking into the microphone. This function requires you to connect an iPhone to the unit via BLUETOOTH. Availability is limited to iPhone 4s or later. Make sure that your iPhone is running the latest iOS version.

You must complete BLUETOOTH registration and connection configurations for the iPhone with the unit in advance. For details, see "Preparing a BLUETOOTH Device (CDE-173EBT/ UTE-73EBT only)" (page 9). To select the iPhone, press and hold /SETUP for at least 2 seconds, then select [BLUETOOTH] → [AUDIO DEVICE] (page 21).

- 1 **Activate the Siri function on the iPhone.**
For details, refer to the operating instructions supplied with the iPhone.
- 2 **Press VOICE.**
The voice command display appears.
- 3 **After the iPhone beeps, speak into the microphone.**
The iPhone beeps again, then Siri starts responding.

To deactivate Siri Eyes Free

Press VOICE.

Notes



- The iPhone may not recognize your voice depending on usage conditions. (For example, if you are in a moving car.)
- Siri Eyes Free may not function properly, or the response time may lag in locations where iPhone signals are difficult to receive.
- Depending on the iPhone's operating condition, Siri Eyes Free may not function properly, or may quit.
- If you play a track with an iPhone using the BLUETOOTH audio connection, when the track starts playback via BLUETOOTH, Siri Eyes Free automatically quits and the unit switches to the BLUETOOTH audio source.
- When Siri Eyes Free is activated during audio playback, the unit may switch to the BLUETOOTH audio source even if you do not specify a track to play.
- When connecting the iPhone to the USB port, Siri Eyes Free may not function properly, or may quit.

- When connecting the iPhone to the unit via USB, do not activate Siri with the iPhone. Siri Eyes Free may not function properly, or may quit.
- There is no audio sound while Siri Eyes Free is activated.

Settings

Canceling the DEMO Mode

You can cancel the demonstration display which appears when the source is off and the clock is displayed.

- 1 Press and hold /SETUP for at least 2 seconds, rotate the control dial to select [GENERAL], then press it.
- 2 Rotate the control dial to select [DEMO MODE], then press it.
- 3 Rotate the control dial to select [DEMO OFF], then press it.
The setting is complete.
- 4 Press  (back) twice.
The display returns to normal reception/play mode.

Basic Setting Operation

You can set items in the following setup categories:

General setup (GENERAL), Audio setup (AUDIO), Display setup (DISPLAY), BLUETOOTH setup (BLUETOOTH)

- 1 Press and hold /SETUP for at least 2 seconds.
- 2 Rotate the control dial to select the setup category, then press it.
The items that can be set differ depending on the source and settings.
- 3 Rotate the control dial to select the options, then press it.

To return to the previous display

Press  (back).

General Setup (GENERAL)

DEMO MODE (demonstration)

Activates the demonstration: [ON], [OFF].

CLOCK ADJ (clock adjust) (page 8)

FM STEP (page 8)

(Available only while the source is off and the clock is displayed.)

CAUTION ALM (caution alarm)

Activates the caution alarm: [ON], [OFF] (page 8).

(Available only while the source is off and the clock is displayed.)

BEEP

Activates the beep sound: [ON], [OFF].

AUTO OFF

Shuts off automatically after a desired time when the unit is turned off: [ON] (30 minutes), [OFF].

USB MODE

Changes the USB mode: [MSC/MTP], [ANDROID].

(Available only when the USB source is selected.)

RDS CT (clock time)

Activates the CT function: [ON], [OFF].

FIRMWARE

(Available only while the source is off and the clock is displayed.)

Checks/updates the firmware version. For details, consult your nearest Alpine dealer.

FW VERSION (firmware version)

Displays current firmware version.

FW UPDATE (firmware update)

Enters firmware update process: [YES], [NO].

Updating the firmware takes a few minutes to complete. During the update, do not turn the ignition to the OFF position, nor remove the USB device.

Audio Setup (AUDIO)

This setup menu is not available when the source is off and the clock is displayed.

EQ PRESET

Selects an equalizer curve from 10 equalizer curves or off:

[USER], [FLAT](OFF), [POPS], [ROCK], [NEWS], [JAZZ], [ELEC DANCE], [HIP HOP], [EASY LIS], [COUNTRY], [CLASSICAL].

The equalizer curve setting can be memorized for each source.

3BAND PEQ (3Band Parametric Equalizer)

Adjusts WIDTH, FREQUENCY and LEVEL for each after BAND is selected.

BAND: [BASS], [MID], [TREBLE].

Setting contents: [WIDTH <Q>], [CENTER FREQ], [LEVEL].

BALANCE

Adjusts the sound balance: [R 15] – [0] – [L 15].

FADER

Adjusts the relative level: [F 15] – [0] – [R 15].

SUBWOOFER

SUBW LEVEL (subwoofer level)

Adjusts the subwoofer volume level:
[OFF], [0] - [+15].

SUBW PHASE (subwoofer phase)

Selects the subwoofer phase: [NORMAL], [REVERSE].

LPF FREQ (low pass filter frequency)

Selects the subwoofer cut-off frequency:
[80Hz], [100Hz], [120Hz].

HPF FREQ (high pass filter frequency)

Selects the front/rear speaker cut-off frequency: [OFF], [80Hz], [100Hz], [120Hz].

AUX VOL (AUX volume level)

Adjusts the volume level for each connected auxiliary device: [+18 dB] – [0 dB] – [-8 dB].

This setting negates the need to adjust the volume level between sources.

(Available only when the AUX is selected.)

BTA VOL (BLUETOOTH audio volume level) (CDE-173EBT/ UTE-73EBT only)

Adjusts the volume level for each connected BLUETOOTH device: [+6 dB] – [0 dB] – [-6 dB].

This setting negates the need to adjust the volume level between sources.

(Available only when the BT audio is selected.)

Display Setup (DISPLAY)

BLACK OUT

If no operation is performed for a while with [ON] set, the display disappears automatically.

Activates the black out: [ON], [OFF].

DIMMER

Changes the display brightness:
[OFF], [ON], [AUTO]*, [CLOCK].

* CDE-173EBT/ UTE-73EBT only

([AUTO] is available only when the illumination control lead is connected, and the head light is turned on.)

To set this function to be active only during a fixed period, select [CLOCK], then set the start and end times.

– To set the brightness when the dimmer function is activated:

Set [DIMMER] to [ON], then adjust [BRIGHTNESS].

– To set the brightness when the dimmer function is deactivated:

Set [DIMMER] to [OFF], then adjust [BRIGHTNESS].

The brightness setting is stored and applied when the dimmer function is activated or deactivated.

BRIGHTNESS

Adjusts the display brightness. The brightness level is adjustable: [1] – [10].

KEY COLOR (CDE-173EBT/ UTE-73EBT only)

Sets a preset color or customized color for the buttons.

OPTION

Selects from 10 presets colors, 1 customized color.

CUSTOMIZE

Registers a customized color for the buttons.

RGB RED, RGB GREEN, RGB BLUE

Adjustable color range: [0] – [32]

([0] cannot be set for all color ranges).

DISP COLOR (display color) (CDE-173EBT/ UTE-73EBT only)

Sets a preset color or customized color for the display.

OPTION

Selects from 10 presets colors, 1 customized color.

CUSTOMIZE

Registers a customized color for the display.

RGB RED, RGB GREEN, RGB BLUE

Adjustable color range: [0] – [32] ([0]

cannot be set for all color ranges).

MUSIC SYNC (music synchronization)

Activates the synchronization of the illumination with the music: [ON], [OFF].

TEXT SCROLL

Scrolls long items automatically: [ON], [OFF].
(Not available when the AUX or tuner is selected.)

BLUETOOTH Setup (BLUETOOTH) (CDE-173EBT/ UTE-73EBT only)

PAIRING (page 9)

Connects up to two BLUETOOTH devices:
[DEVICE 1], [DEVICE 2].
[DEVICE 1] or [DEVICE 2] will be changed to the paired device name after pairing is complete.

AUDIO DEVICE

Selects the audio device.

[*] appears on the device paired with [DEVICE 1] or the current A2DP compatible audio device.

RINGTONE

Selects whether this unit or the connected cellular phone outputs the ringtone: [1] (this unit), [2] (cellular phone).

AUTO ANSWER

Sets this unit to answer an incoming call automatically: [OFF], [1] (about 3 seconds), [2] (about 10 seconds).

AUTO PAIR (auto pairing)

Starts BLUETOOTH pairing automatically when iOS device version 5.0 or later is connected via USB: [ON], [OFF].

BT IN (page 10)

Activates/deactivates the BLUETOOTH function.

BT INITIAL (BLUETOOTH initialize)

Initializes all the BLUETOOTH related settings (pairing information, preset number, device information, etc.): [YES], [NO].

When disposing the unit, initialize all the settings.

(Available only while the source is off and the clock is displayed.)

Additional Information

Updating the Firmware

To update the firmware, visit the Alpine website.
<http://www.alpine-asia.com>

Notes

- Using a USB device (not supplied) is required for updating the firmware. Store the updater in the USB device, and connect the device to the USB port, then perform the update operation.
- Updating the firmware takes a few minutes to complete. During the update, do not turn the ignition to the OFF position, nor remove the USB device.

Precautions

- Cool off the unit beforehand if your car has been parked in direct sunlight.
- Do not leave the front panel or audio devices brought in inside the car, or it may cause malfunction due to high temperature in direct sunlight.
- Power antenna (aerial) extends automatically.

Moisture condensation

Should moisture condensation occur inside the unit, remove the disc and wait for about an hour for it to dry out; otherwise the unit will not operate properly.

To maintain high sound quality

Do not splash liquid onto the unit or discs.

Notes on discs (CDE-173EBT/ CDE-170E only)

- Do not expose discs to direct sunlight or heat sources such as hot air ducts, nor leave it in a car parked in direct sunlight.
- Before playing, wipe the discs with a cleaning cloth from the center out. Do not use solvents such as benzene, thinner, commercially available cleaners.



- This unit is designed to play discs that conform to the Compact Disc (CD) standard. DualDiscs and some of the music discs encoded with copyright protection technologies do not conform to the Compact Disc (CD) standard, therefore, these discs may not be playable by this unit.
- Discs that this unit CANNOT play
 - Discs with labels, stickers, or sticky tape or paper attached. Doing so may cause a malfunction, or may ruin the disc.
 - Discs with non-standard shapes (e.g., heart, square, star). Attempting to do so may damage the unit.
 - 8 cm (3 1/4 in) discs.

Notes on CD-R/CD-RW discs

- If the multi-session disc begins with a CD-DA session, it is recognized as a CD-DA disc, and other sessions are not played.
- Discs that this unit CANNOT play
 - CD-R/CD-RW of poor recording quality.
 - CD-R/CD-RW recorded with an incompatible recording device.
 - CD-R/CD-RW which is finalized incorrectly.
 - CD-R/CD-RW other than those recorded in music CD format or MP3 format conforming to ISO9660 Level 1/Level 2, Joliet/Romeo or multi-session.

Playback order of audio files

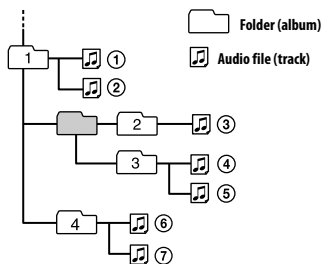

About iPod (CDE-173EBT/ UTE-73EBT only)

- You can connect to the following iPod models. Update your iPod devices to the latest software before use.

Compatible iPhone/iPod models

Compatible Model	Bluetooth®	USB
iPhone 7	✓	✓
iPhone 7 Plus	✓	✓
iPhone SE	✓	✓
iPhone 6s	✓	✓
iPhone 6s Plus	✓	✓
iPhone 6	✓	✓
iPhone 6 Plus	✓	✓
iPhone 5s	✓	✓
iPhone 5c	✓	✓
iPhone 5	✓	✓
iPhone 4s	✓	✓
iPod touch (6th generation)	✓	✓
iPod touch (5th generation)	✓	✓
iPod nano (7th generation)		✓

- Use of the Made for Apple badge means that an accessory has been designed to connect specifically to the Apple product(s) identified in the badge, and has been certified by the developer to meet Apple performance standards. Apple is not responsible for the operation of this device or its compliance with safety and regulatory standards. Please note that the use of this accessory with an Apple product may affect wireless performance.

If you have any questions or problems concerning your unit that are not covered in this manual, consult your nearest Alpine dealer.

Maintenance

Cleaning the connectors

The unit may not function properly if the connectors between the unit and the front panel are not clean. In order to prevent this, detach the front panel (page 8) and clean the connectors with a cotton swab. Do not apply too much force. Otherwise, the connectors may be damaged.

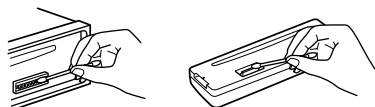

Notes

- For safety, turn off the ignition before cleaning the connectors, and remove the key from the ignition switch.
- Never touch the connectors directly with your fingers or with any metal device.

Specifications

Tuner section

FM

Tuning range:

87.5 MHz – 108.0 MHz

FM tuning step:

50 kHz/100 kHz switchable

Antenna (aerial) terminal:

External antenna (aerial) connector

Intermediate frequency:

FM CCIR: -1,956.5 kHz to -487.3 kHz and +500.0 kHz to +2,095.4 kHz

Usable sensitivity: 8 dBf

Selectivity: 75 dB at 400 kHz

Signal-to-noise ratio: 73 dB

Separation: 50 dB at 1 kHz

Frequency response: 20 Hz – 15,000 Hz

AM

Tuning range:

531 kHz – 1,602 kHz (at 9 kHz step)

Antenna (aerial) terminal:

External antenna (aerial) connector

Sensitivity: 26 μ V

CD Player section (CDE-173EBT/ CDE-170E only)

Signal-to-noise ratio: 95 dB

Frequency response: 20 Hz – 20,000 Hz

Wow and flutter: Below measurable limit

Maximum number*1 of:

Folders (albums)^{*2}: 150

Files (tracks) and folders^{*3}: 300

Displayable characters for a folder/file name:
32 (Joliet)/64 (Romeo)

Corresponding codec: MP3 (.mp3), WMA (.wma)
and AAC (.m4a)^{*4}

*1 CD-R/CD-RW only

*2 including the root folder

*3 may be less than the measured value if folder/
file names contain many characters

*4 CDE-173EBT only

USB Player section

Interface: USB (Full-speed)

Maximum current:

CDE-173EBT/ UTE-73EBT: 1 A

CDE-170E: 500 mA

The maximum number of recognizable tracks:

– folders (albums): 256

– files (tracks) per folder: 256

Compatible Android Open Accessory protocol
(AOA): 2.0

Corresponding codec:

MP3 (.mp3)

Bit rate: 8 kbps – 320 kbps (Supports VBR
(Variable Bit Rate))

Sampling rate: 16 kHz – 48 kHz

WMA (.wma)

Bit rate: 32 kbps – 192 kbps (Supports VBR
(Variable Bit Rate))

Sampling rate: 32 kHz, 44.1 kHz,
48 kHz

FLAC (.flac)

Bit depth: 16 bit, 24 bit

Sampling rate: 44.1 kHz, 48 kHz

AAC (.m4a) (CDE-173EBT/ UTE-73EBT only)

Bit rate: 8 kbps – 320 kbps

Sampling rate: 11.025 kHz – 48 kHz

Wireless Communication (CDE-173EBT/ UTE-73EBT only)

Communication System:

BLUETOOTH Standard version 3.0

Output:

BLUETOOTH Standard Power Class 2
(Conducted MAX +1 dBm)

Maximum communication range:

Line of sight approx. 10 m (33 ft)^{*1}

Frequency band:

2.4 GHz band

(2.4000 GHz – 2.4835 GHz)

Modulation method: FHSS

Compatible BLUETOOTH Profiles^{*2}:

A2DP (Advanced Audio Distribution Profile)
1.3

AVRCP (Audio Video Remote Control Profile)
1.3

HFP (Handsfree Profile) 1.6

PBAP (Phone Book Access Profile)

SPP (Serial Port Profile)

Corresponding codec:

SBC (.sbc), AAC (.m4a)

*1 The actual range will vary depending on factors such as obstacles between devices, magnetic fields around a microwave oven, static electricity, reception sensitivity, antenna (aerial)'s performance, operating system, software application, etc.

*2 BLUETOOTH standard profiles indicate the purpose of BLUETOOTH communication between devices.

Power amplifier section

Output: Speaker outputs

Speaker impedance: 4 Ω – 8 Ω

Maximum power output: 50 W × 4 (at 4 Ω)

General

Outputs:

Audio outputs terminal:
FRONT, SUB

Power requirements: 12 V DC car battery
(negative ground (earth))

Rated current consumption: 10 A

Dimensions:

Approx. 178 mm × 50 mm × 177 mm
(7 1/8 in × 2 in × 7 in) (w/h/d)

Mounting dimensions:

Approx. 182 mm × 53 mm × 159 mm
(7 1/4 in × 2 1/8 in × 6 3/8 in) (w/h/d)

Mass:

CDE-173EBT/ CDE-170E: Approx. 1.2 kg (2 lb
11 oz)

UTE-73EBT: Approx. 0.8 kg (1 lb 10 oz)

Package contents:

- Main unit (1)
- Microphone (1) (CDE-173EBT/ UTE-73EBT only)
- Parts for installation and connections (1 set)

Your dealer may not handle some of the above listed accessories. Please ask the dealer for detailed information.

Design and specifications are subject to change without notice.

Copyrights

The Bluetooth® word mark and logos are registered trademarks owned by Bluetooth SIG, Inc. and any use of such marks by Alpine Electronics, Inc. is under license.

Windows Media and the Windows logo are trademarks, or registered trademarks of Microsoft Corporation in the United States and/ or other countries.

This product is protected by certain intellectual property rights of Microsoft Corporation. Use or distribution of such technology outside of this product is prohibited without a license from Microsoft or an authorized Microsoft subsidiary.

Apple, iPhone, iPod, iPod nano, iPod touch, and Siri are trademarks of Apple Inc., registered in the U.S. and other countries.

MPEG Layer-3 audio coding technology and patents licensed from Fraunhofer IIS and Thomson.

Google, Google Play and Android are trademarks of Google LLC.

libFLAC

Copyright (C) 2000-2009 Josh Coalson
Copyright (C) 2011-2013 Xiph.Org Foundation

Redistribution and use in source and binary forms, with or without modification, are permitted provided that the following conditions are met:

- Redistributions of source code must retain the above copyright notice, this list of conditions and the following disclaimer.
- Redistributions in binary form must reproduce the above copyright notice, this list of conditions and the following disclaimer in the documentation and/or other materials provided with the distribution.
- Neither the name of the Xiph.org Foundation nor the names of its contributors may be used to endorse or promote products derived from this software without specific prior written permission.

THIS SOFTWARE IS PROVIDED BY THE COPYRIGHT HOLDERS AND CONTRIBUTORS "AS IS" AND ANY EXPRESS OR IMPLIED WARRANTIES, INCLUDING, BUT NOT LIMITED TO, THE IMPLIED WARRANTIES OF MERCHANTABILITY AND FITNESS FOR A PARTICULAR PURPOSE ARE DISCLAIMED. IN NO EVENT SHALL THE FOUNDATION OR CONTRIBUTORS BE LIABLE FOR ANY DIRECT, INDIRECT, INCIDENTAL, SPECIAL, EXEMPLARY, OR CONSEQUENTIAL DAMAGES (INCLUDING, BUT NOT LIMITED TO, PROCUREMENT OF SUBSTITUTE GOODS OR SERVICES; LOSS OF USE, DATA, OR PROFITS; OR BUSINESS INTERRUPTION) HOWEVER CAUSED AND ON ANY THEORY OF LIABILITY, WHETHER IN CONTRACT, STRICT LIABILITY, OR TORT (INCLUDING NEGLIGENCE OR OTHERWISE) ARISING IN ANY WAY OUT OF THE USE OF THIS SOFTWARE, EVEN IF ADVISED OF THE POSSIBILITY OF SUCH DAMAGE.

Troubleshooting

The following checklist will help you remedy problems you may encounter with your unit. Before going through the checklist below, check the connection and operating procedures. For details on using the fuse and removing the unit from the dashboard, see "Connection/Installation" (page 30).

If the problem is not solved, please contact your authorized Alpine dealer for assistance.

General

No sound or the sound is very low.

- The position of the fader control [FADER] is not set for a 2-speaker system.
- The volume of the unit and/or connected device is very low.
 - Increase the volume of the unit and connected device.

No beep sound.

- An optional power amplifier is connected and you are not using the built-in amplifier.

The contents of the memory have been erased.

- The power supply lead or battery has been disconnected or not connected properly.

Stored stations and correct time are erased.

The fuse has blown.



Makes a noise when the position of the ignition is switched.

- The leads are not matched correctly with the car's accessory power connector.

During playback or reception, the demonstration mode starts.

- If no operation is performed for 5 minutes with [DEMO ON] set, the demonstration mode starts.
 - Set [DEMO OFF] (page 19).

The display disappears from/does not appear in the display window.

- The dimmer is set to [DIMMER ON] (page 20).
- The display disappears if you press and hold  (power).
 - Press  (power) on the unit until the display appears.
- The connectors are dirty (page 23).

The display disappears while the unit is operating.

- [BLACK OUT] is set to [ON] (page 20).

The display/illumination flashes.

- The power supply is not sufficient.
 - Check that the car battery supplies enough power to the unit. (The power requirement is 12 V DC.)

The operation buttons do not function.

The disc will not eject.

- Press  and Number button 6 for more than 2 seconds to reset the unit. The contents stored in memory are erased. For your safety, do not reset the unit while you are driving.

Radio reception

Stations cannot be received.

The sound is hampered by noises.

- The connection is not correct.
 - Check the connection of the car antenna (aerial).
 - If the auto antenna (aerial) will not extend, check the connection of the power antenna (aerial) control lead.

Preset tuning is not possible.

- The broadcast signal is too weak.

RDS

PTY displays [- - - - -].

- The current station is not an RDS station.
- RDS data has not been received.
- The station does not specify the program type.

CD playback

The disc does not play.

- Defective or dirty disc.
- The CD-R/CD-RW is not for audio use (page 22).

MP3/WMA/AAC files cannot be played.

- The disc is incompatible with the MP3/WMA/AAC format and version.

MP3/WMA/AAC files take longer to play than others.

- The following discs take a longer time to start playback.
 - A disc recorded with a complicated tree structure.
 - A disc recorded in Multi Session.
 - A disc to which data can be added.

The sound skips.

- Defective or dirty disc.

USB device playback

You cannot play items via a USB hub.

- This unit cannot recognize USB devices via a USB hub.

A USB device takes longer to play.

- The USB device contains files with a complicated tree structure.

The sound is intermittent.

- The sound may be intermittent at a high-bit-rate.
- DRM (Digital Rights Management) files may not be playable in some cases.

The audio file cannot be played.

- USB devices formatted with file systems other than FAT16 or FAT32 are unsupported.*

* This unit supports FAT16 and FAT32, but some USB device may not support all of these FAT. For details, refer to the operating instruction of each USB device or contact the manufacturer.

Operations for skipping an album, skipping items (Jump mode), and searching a track by name cannot be performed.

- These operations cannot be performed when a USB device in Android mode or iPod is connected.
 - Set [USB MODE] to [MSC/MTP] (page 19).
 - Remove the iPod.
- The USB mode of the device is not set to the appropriate mode.
 - Make sure that the USB mode of the device is set to MSC/MTP mode.

The sound cannot be output during playback in Android mode.

- While the unit is in ANDROID mode, the sound outputs only from the Android smartphone.
 - Check the status of the audio playback application on the Android smartphone.
 - Playback may not perform properly depending on the Android smartphone.

BLUETOOTH function

The connecting device cannot detect this unit.

- Before the pairing is made, set this unit to pairing standby mode.
- While connected to two BLUETOOTH devices, this unit cannot be detected from another device.
 - Disconnect either connection and search for this unit from another device.
- When the device pairing is made, set the BLUETOOTH signal output to on (page 10).

Connection is not possible.

- The connection is controlled from one side (this unit or BLUETOOTH device), but not both.
 - Connect to this unit from a BLUETOOTH device or vice versa.

The name of the detected device does not appear.

- Depending on the status of the other device, it may not be possible to obtain the name.

No ringtone.

- Adjust the volume by rotating the control dial while receiving a call.
- Depending on the connecting device, the ringtone may not be sent properly.
 - Set [RINGTONE] to [1] (page 21).

- The front speakers are not connected to the unit.
 - Connect the front speakers to the unit. The ringtone is output only from the front speakers.

The talker's voice cannot be heard.

- The front speakers are not connected to the unit.
 - Connect the front speakers to the unit. The talker's voice is output only from the front speakers.

A call partner says that the volume is too low or high.

- Adjust the volume accordingly using Mic gain adjustment (page 16).

Echo or noise occurs in phone call conversations.

- Lower the volume.
- Set EC/NC Mode to [BTP EC/NC 1] or [BTP EC/NC 2] (page 16).
- If the ambient noise other than the phone call sound is loud, try reducing this noise.
E.g.: If a window is open and road noise, etc., is loud, shut the window. If an air conditioner is loud, lower the air conditioner.

The phone is not connected.

- When BLUETOOTH audio is played, the phone is not connected even if you press 
 - Connect from the phone.

The phone sound quality is poor.

- Phone sound quality depends on reception conditions of cellular phone.
 - Move your car to a place where you can enhance the cellular phone's signal if the reception is poor.

The volume of the connected audio device is low (high).

- Volume level will differ depending on the audio device.
 - Adjust the volume of the connected audio device or this unit (page 20).

The sound skips during playback of a BLUETOOTH audio device.

- Reduce the distance between the unit and the BLUETOOTH audio device.
- If the BLUETOOTH audio device is stored in a case which interrupts the signal, remove the audio device from the case during use.
- Several BLUETOOTH devices or other devices which emit radio waves are in use nearby.
 - Turn off the other devices.
 - Increase the distance from the other devices.
- The playback sound stops momentarily when the connection between this unit and the cellular phone is being made. This is not a malfunction.

The connected BLUETOOTH audio device cannot be controlled.

- Check that the connected BLUETOOTH audio device supports AVRCP.

Some functions do not work.

- Check if the connecting device supports the functions in question.

A call is answered unintentionally.

- The connecting phone is set to answer a call automatically.

Pairing failed due to a timeout.

- Depending on the connecting device, the time limit for pairing may be short.
 - Try completing the pairing within the time.

BLUETOOTH function cannot operate.

- Turn off the unit by pressing  (power) for more than 2 seconds, then turn the unit on again.

No sound is output from the car speakers during handsfree call.

- If the sound is output from the cellular phone, set the cellular phone to output the sound from the car speakers.

Siri Eyes Free is not activated.

- Perform the handsfree registration for an iPhone that supports Siri Eyes Free.
- Set the Siri function on the iPhone to on.
- Cancel the BLUETOOTH connection with the iPhone and the unit, and reconnect.

Messages

The following messages may appear or flash during operation.

If these solutions do not help improve the situation, consult your nearest Alpine dealer. If you take the unit to be repaired because of CD playback trouble, bring the disc that was used at the time the problem began.

CD ERROR: The disc cannot be played. The disc will be ejected automatically.

→ Clean or insert the disc correctly, or make sure the disc is not blank or defective.

CD NO MUSIC: There is no playable file. The disc will be ejected automatically.

→ Insert a disc containing playable files (page 24).

CD PUSH EJT: The disc could not be ejected properly.

→ Press and hold  (eject).

HUB NO SUPRT: USB hubs are not supported.

INVALID

→ The selected operation could be invalid.

→ [USB MODE] cannot be changed during iPod playback.

IPD STOP: iPod playback has finished.

→ Operate your iPod/iPhone to start playback.

NOT SUPPORT - ANDROID MODE

→ A USB device not supporting AOA (Android Open Accessory) 2.0 is connected to the unit while [USB MODE] is set to [ANDROID].

– Set [USB MODE] to [MSC/MTP] (page 19).

OVERLOAD: The USB device is overloaded.

→ Disconnect the USB device, then press SOURCE  to select another source.

→ The USB device has a fault, or an unsupported device is connected.

READ: Now reading information.

→ Wait until reading is complete and playback starts automatically. This may take some time depending on the file organization.

USB ERROR: The USB device cannot be played.

→ Connect the USB device again.

USB NO DEV: A USB device is not connected or recognized.

→ Make sure the USB device or USB cable is securely connected.

USB NO MUSIC: There is no playable file.

→ Connect a USB device containing playable files (page 24).

USB NO SUPRT: The USB device is not supported.

→ For details on the compatibility of your USB device, consult your nearest Alpine dealer.

LLLL or ׀׀׀׀׀: The beginning or the end of the disc has been reached.

_ (underscore): The character cannot be displayed.

For BLUETOOTH function:

BTA NO DEV: The BLUETOOTH device is not connected or recognized.

→ Make sure the BLUETOOTH device is securely connected, or the BLUETOOTH connection is established with the BLUETOOTH device.

ERROR: The selected operation could not be performed.

→ Wait for a while, then try again.

UNKNOWN: A name or phone number cannot be displayed.

WITHHELD: The phone number is hidden by the caller.

Connection/Installation

Cautions

- Run all ground (earth) leads to a common ground (earth) point.
- Do not get the leads trapped under a screw, or caught in moving parts (e.g., seat railing).
- Before making connections, turn the car ignition off to avoid short circuits.
- Connect the **yellow** and **red** power supply leads only after all other leads have been connected.
- Be sure to insulate any loose unconnected leads with electrical tape for safety.

Precautions

- Choose the installation location carefully so that the unit will not interfere with normal driving operations.
- Avoid installing the unit in areas subject to dust, dirt, excessive vibration, or high temperature, such as in direct sunlight or near heater ducts.
- Use only the supplied mounting hardware for a safe and secure installation.

Note on the power supply lead (yellow)

When connecting this unit in combination with other stereo components, the amperage rating of the car circuit to which the unit is connected must be higher than the sum of each component's fuse amperage rating.

Mounting angle adjustment

Adjust the mounting angle to less than 30°.

Parts List for Installation

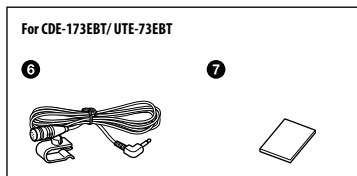
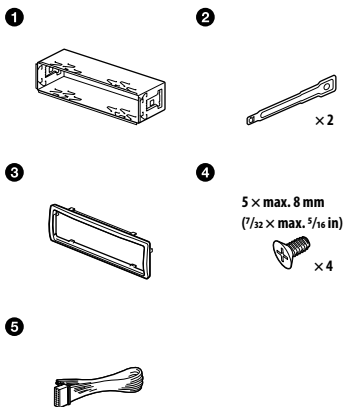

- This parts list does not include all the package contents.
- The bracket **1** and the protection collar **3** are attached to the unit before shipping. Before mounting the unit, use the release keys **2** to remove the bracket **1** from the unit. For details, see "Removing the protection collar and the bracket" (page 34).
- Keep the release keys **2** for future use as they are also necessary if you remove the unit from your car.

Connection

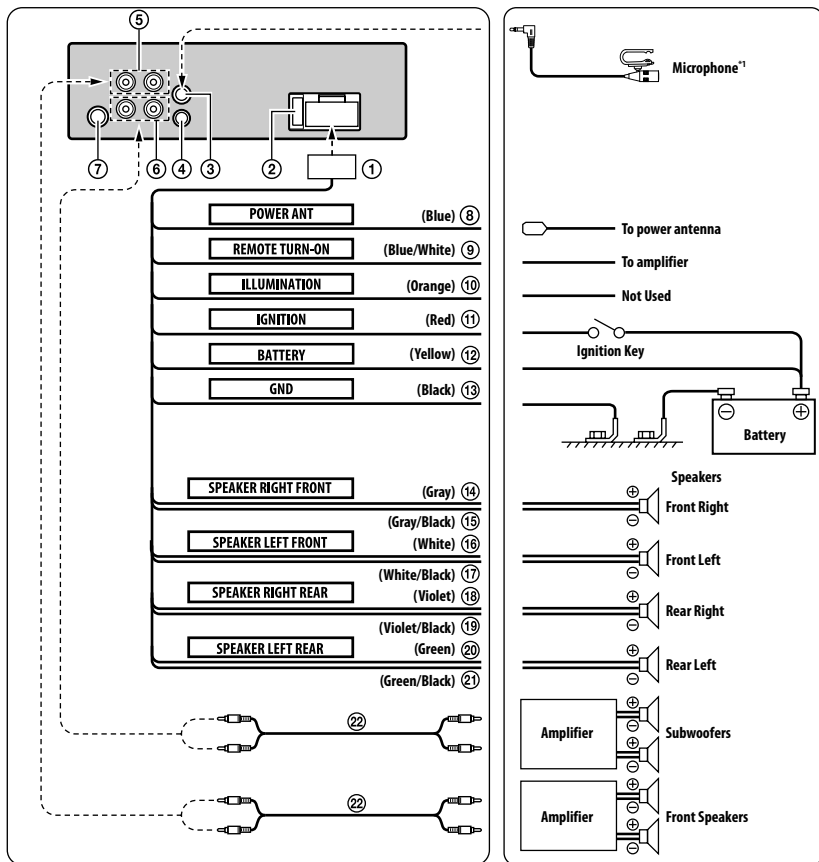

*1 Whether in use or not, route the microphone input cord such that it does not interfere with driving operations. Secure the cord with a clamp, etc., if it is installed around your feet. For details on installing the microphone, see "Installing the microphone (CDE-173EBT/ UTE-73EBT only)" (page 34).

① Power Supply Connector

② Fuse Holder (10A)

Fuse replacement:

When replacing the fuse, be sure to use one matching the amperage rating stated on the original fuse. If the fuse blows, check the power connection and replace the fuse. If the fuse blows again after replacement, there may be an internal malfunction. In such a case, consult your nearest Alpine dealer.

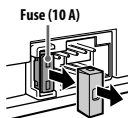

③ MIC Input Connector (CDE-173EBT/ UTE-73EBT only)

To Microphone.

④ Steering Remote Control Interface Connector

To steering remote control interface box. You can operate this unit from the vehicle's control unit when an Alpine Steering Remote Control Interface Box (optional) is connected. For details, contact your Alpine dealer.

⑤ Front Output RCA Connectors

RED is right and WHITE is left.

⑥ Subwoofer Output RCA Connectors

⑦ Antenna Receptacle

⑧ Power Antenna Lead (Blue)

Connect this lead to the +B terminal of your power antenna, if applicable.

- This lead should be used only for controlling the vehicle's power antenna. Do not use this lead to turn on an amplifier or a signal processor, etc.

⑨ Remote Turn-On Lead (Blue/White)

Connect this lead to the remote turn-on lead of your amplifier or signal processor.

⑩ Illumination Lead (Orange) (CDE-173EBT/ UTE-73EBT only)

This lead may be connected to the vehicle's instrument cluster illumination lead. This will enable the vehicle's dimmer control to dim the backlighting of the unit.

⑪ Switched Power Lead (Ignition) (Red)

Connect this lead to an open terminal on the vehicle's fuse box or another unused power source which provides (+) 12V only when the ignition is turned on or in the accessory position.

⑫ Battery Lead (Yellow)

Connect this lead to the positive (+) post of the vehicle's battery.

⑬ Ground Lead (Black)

Connect this lead to a good chassis ground on the vehicle. Make sure the connection is made to bare metal and is securely fastened using the sheet metal screw provided.

⑭ Right Front (+) Speaker Output Lead (Gray)

⑮ Right Front (-) Speaker Output Lead (Gray/ Black)

⑯ Left Front (+) Speaker Output Lead (White)

⑰ Left Front (-) Speaker Output Lead (White/ Black)

⑱ Right Rear (+) Speaker Output Lead (Violet)

⑲ Right Rear (-) Speaker Output Lead (Violet/Black)

⑳ Left Rear (+) Speaker Output Lead (Green)

㉑ Left Rear (-) Speaker Output Lead (Green/ Black)

㉒ RCA Extension Cable (not supplied)

To prevent external noise from entering the audio system.

- Locate the unit and route the leads at least 10 cm away from the car harness.
- Keep the battery power leads as far away from other leads as possible.
- Connect the ground lead securely to a bare metal spot (remove any paint, dirt or grease if necessary) of the car chassis.
- If you add an optional noise suppressor, connect it as far away from the unit as possible. Your Alpine dealer carries various noise suppressors, contact them for further information.
- Your Alpine dealer knows best about noise prevention measures so consult your dealer for further information.

Installing the microphone (CDE-173EBT/ UTE-73EBT only)

To capture your voice during handsfree calling, you need to install the microphone ⑥.

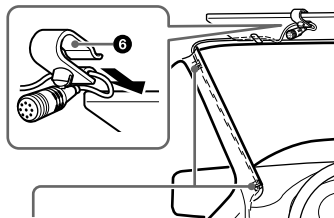

Clip (not supplied)

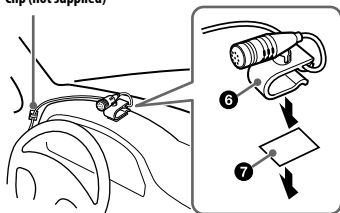

Cautions

- It is extremely dangerous if the cord becomes wound around the steering column or shift lever. Be sure to keep it and other parts from interfering with your driving operations.
- If airbags or any other shock-absorbing equipment is in your car, contact the store where you purchased this unit, or the car dealer, before installation.

Note

Before attaching the double-sided tape ⑦, clean the surface of the dashboard with a dry cloth.

Installation

Removing the protection collar and the bracket

Before installing the unit, remove the protection collar ③ and the bracket ① from the unit.

- 1 Pinch both edges of the protection collar ③, then pull it out.

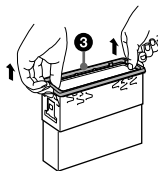

- 2 Insert both release keys ② until they click, and pull down the bracket ①, then pull up the unit to separate.

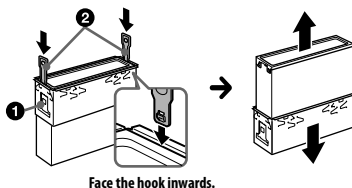

Mounting the unit in the dashboard

- Before installing, make sure the catches on both sides of the bracket **1** are bent inwards 2 mm ($\frac{3}{32}$ in).
- For Japanese cars, see "Mounting the unit in a Japanese car" (page 35).

- 1** Position the bracket **1** inside the dashboard, then bend the claws outward for a tight fit.

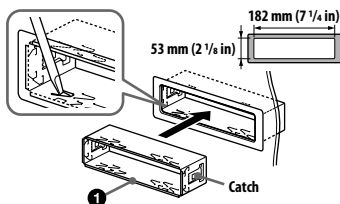

- 2** Mount the unit onto the bracket **1**, then attach the protection collar **3**.

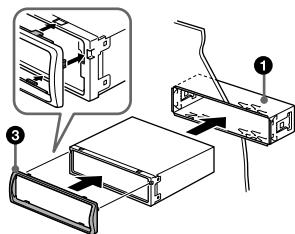

Notes

- If the catches are straight or bent outwards, the unit will not be installed securely and may spring out.
- Make sure the 4 catches on the protection collar **3** are properly engaged in the slots of the unit.

Mounting the unit in a Japanese car

You may not be able to install this unit in some makes of Japanese cars. In such a case, consult your Alpine dealer.

TOYOTA

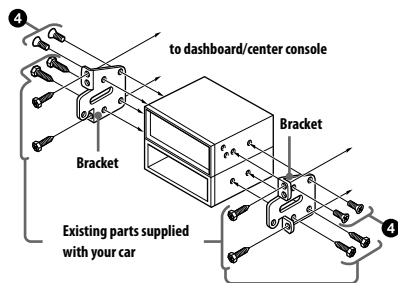

NISSAN

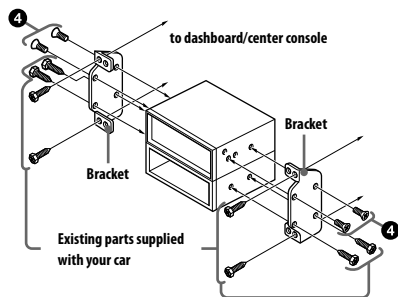

Note

To prevent malfunction, install only with the supplied screws **4**.

Detaching and attaching the front panel

For details, see "Detaching the Front Panel" (page 8).

Resetting the unit

For details, see "Resetting the Unit" (page 8).

