

ALPINE®

12-channel High-quality Audio Processor

PXE-0850X



- For iPhone mobile phone users, please search PXE-0850X tuning APP in APP Store and download it for installation.
- For Android mobile phone users, scan the QR code on the right side to directly download for installation



Tuning APP

Contents

Operating Instructions

Warning	1
Caution	1

Machine Introduction

Machine Interface Diagram	2
Machine Interface and Function Introduction	3
Parts List	3

Operating Instructions of Mobile Phone APP

Interface Introduction	4
Homepage Interface	4
Machine Connection	4
Menu Bar Introduction	4
Sound Source Selection	4
Master Volume Setting	4
Sound Effect Setting	5
Delay Interface	5
Channel Interface	5
Frequency Divider Setting	5
Output Channel Setting	5
EQ Interface	5
Frequency Combination Interface ...	6

Operating Instructions of Computer Software

Notes for Software Installation	7
Main Interface	7

Function Menu	8
Sound Source Selection	9
Master Volume Setting	9
Sound Effect Setting	9
Output Channel Type, Mute and Joint Debugging Setting	9
Output Channel Delay, Phase Position and Volume Setting	10
Frequency Divider Setting	10
Channel EQ Setting	10
Function Introduction for Frequency Combination Setting	11

Operating Instructions of Wire Controller

Startup Picture	13
Master Volume (VOLUME)	13
Main Sound Source (MAIN SOURCE)	13
Auxiliary Sound Source (MIX SOURCE)	13
Bass Volume (SUB W)	13
Preset Sound Effect (PRESET)	13

Technical Parameters

Specification Parameters	14
Function Parameters	14

Information

Harmful Substance Composition ...	15
Maintenance Station Information ...	15

Operating Instructions



Warning

This sign shows important indications. It may cause serious injury or death if you don't pay attention to them.

When something goes wrong, please stop using it immediately.

Please return this product to the authorized dealer of Alpine or nearby Alpine service center for repair.

Do not use any function that will distract you while driving

Any machine function that will affect attention must be operated only after the car has completely stopped. Be sure to park the car in a safe zone first before using these functions. Otherwise, it may lead to accidents.

While driving, you must keep the volume level so that you can still hear the noise outside the car.

If the volume is so loud that emergency vehicle alarms and road warning signals (train intersection, etc.) cannot be heard clearly, it is dangerous and may lead to accidents. In addition, listening in at high volume in the car may cause hearing damage.

Do not disassemble or transform

Otherwise, it may lead to accident, fire or electric shock.

Keep children away from small objects such as bolts or screws

Swallowing small objects can cause serious injury. If it is swallowed by mistake, consult a doctor immediately.

Please apply this product to a 12V type car

If this product is applied to another type of cars, it may cause fire, electric shock or other injuries.



Caution

This sign shows important indications. It may cause personal injury or damage to equipment if you don't pay attention to them.

Product Cleaning

Please clean this product regularly with dry soft cloth. If it is difficult to remove the dirt, please soak the soft cloth with water only. Any other solvent may dissolve this product.

Temperature

Before starting up the machine, please ensure that the temperature inside the car is between +60 °C and -20°C .

Installation Position

Make sure that the machine is not installed in any of the following places:

- under direct sunlight and nearby heat source;
 - with high humidity or nearby water source;
 - dusty and
 - places with violent vibrations.
-

Maintenance

If you encounter a problem, please do not repair by yourself. Please return this product to the authorized dealer of Alpine or nearby Alpine service center for repair.

Certification

The literal symbols and logo of *Bluetooth®* are the registered trademarks of Bluetooth SIG.

The relevant literal symbols and logo used by Alpine have been authorized.

Other trademarks and product names belong to their respective owners.

Machine Introduction

Machine Interface Diagram

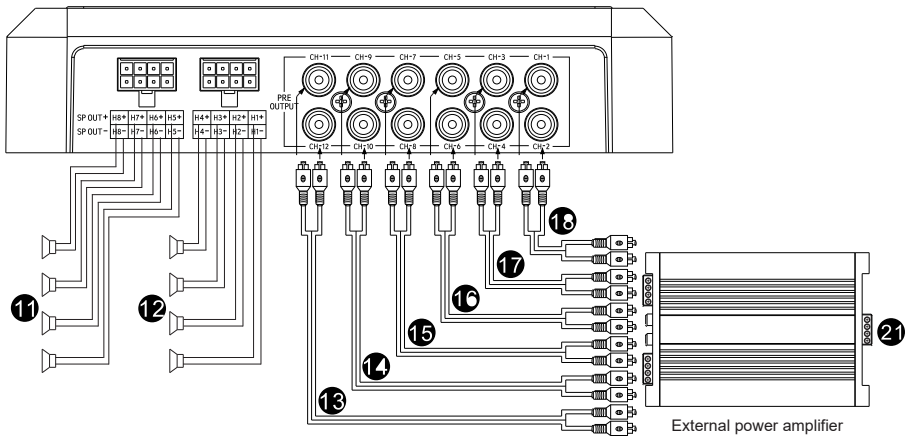
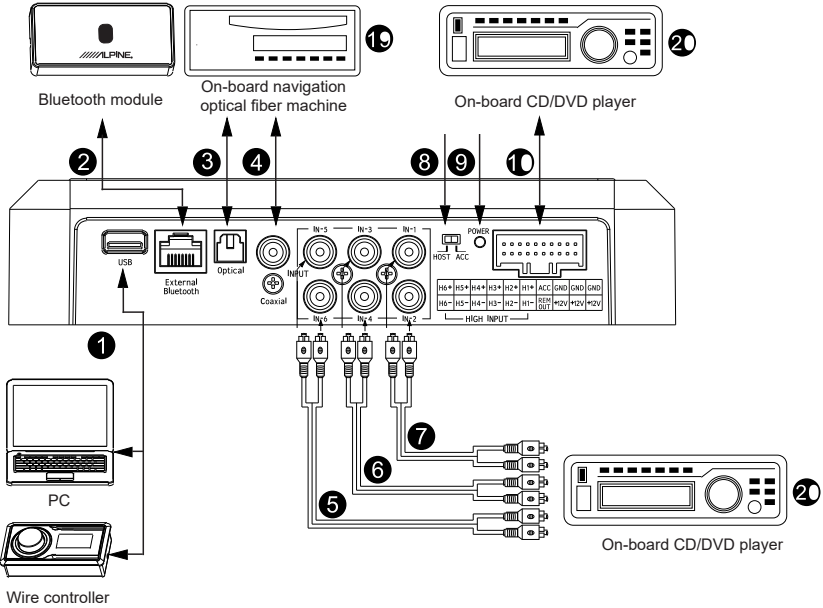

Machine Introduction

Machine Interface and Function Introduction

① Host USB 3.0 Interface

The host USB interface is connected to the computer through USB 3.0 wire, and PXE-0850X computer software is opened for tuning setting. The USB interface may be connected to the wire controller through USB 3.0 wire to perform tuning setting.

② External Bluetooth Interface

Select high-definition Bluetooth as an input signal, or connect PXE-0850X mobile phone tuning APP. After successful connection, the Bluetooth light is normally on.

③④ Optical Fiber and Coaxial Interface

Connect the on-board CD/DVD optical fiber or coaxial line and switch the sound source of the machine to digital signal input to play optical fiber or coaxial digital signals.

⑤⑥⑦ RCA Audio Input Interface

3 groups of RCA audio signal inputs may be connected to the RCA audio signal output of the on-board CD/DVD player

⑧ Input Selection Switch

When the switch is switched to the "ACC" terminal, the machine will be started by ACC; and when the it is switched to the "HOST"

terminal, the machine will be started by the high level input signal H1-/H1+.

⑨ Power Indicator Light

⑩ High Level Input and Power Interface

They are connected to the high level output of the on-board CD/DVD player.

H6+	H5+	H4+	H3+	H2+	H1+	ACC	GND	GND	GND
H6-	H5-	H4-	H3-	H2-	H1-	REM OUT	+12V	+12V	+12V

⑪⑫ High Level Output Interface

The output of the machine power amplifier is connected to the loudspeaker.

⑬⑭⑮⑯⑰⑱ RCA Audio Output Interface

6 groups of RCA audio signal outputs may be connected to the external power amplifier.

⑲ On-board navigation optical fiber machine

⑳ On-board CD/DVD player

㉑ External power amplifier

Parts List

The PXE-0850X packaging box shall include the following parts. For any shortage, please contact the authorized dealer of Alpine.

Parts	Quantity
Bluetooth module	1 (piece)
Wire controller	1 (piece)
Power line	1 (piece)
Horn wire	1 (piece)
USB 3.0 wire	1 (piece)
Fixing bracket	2 (pieces)
Quick operation guide	1 (copy)

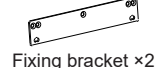
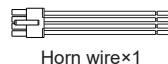
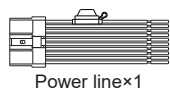
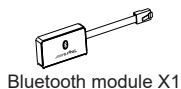

Operating Instructions of Mobile Phone APP

After the PXE-0850X APP has been successfully installed on the mobile phone, the PXE-0850X machine will be started. Open mobile phone "Settings"→"Enabling Bluetooth"→"Searching Device"→"DSP-HD-...", click connection, or directly open the PXE-0850X APP to automatically search Bluetooth, click to connect "DSP-HD-...", which will indicate successful connection after displaying 100% data synchronization.

Read the disclaimer carefully and click "Accept" to enter the homepage interface.



Interface Introduction



There are five interfaces with different functions, including delay, channel, homepage, EQ and frequency combination. Enter the homepage interface by default.

Homepage Interface



Machine Connection

If the Bluetooth icon shows red [❌], the Bluetooth of the mobile phone is not connected; and if the Bluetooth icon shows green [✅], the Bluetooth of the mobile phone is connected.

Menu Bar Introduction

Click the menu bar [☰] at the upper right corner to enter "Encrypt", "Share Sound Effect", "Save Sound Effect", "Local Sound Effect" and "About" operations.

1. Select "Encrypt" to enter a 6-digit encrypted password to encrypt the already tuned sound effect data. Click "Decrypt" to enter the correct password to decrypt the already encrypted data; and on the decryption interface, click "Clear Data" to remove by one key the encryption state and restore the data to the ex-factory state.
2. Select "Share Sound Effect" to choose single group sharing or whole machine sharing.
3. Select "Save Sound Effect" to input the file name and remarks, and you can choose single group or whole machine saving.
4. Select "Local Sound Effect" to call sound effect files saved in the mobile phone.
5. Select "About" to view the device version.

Sound Source Selection

1. Main sound source: click the button below the main sound source, and select the main sound source: digital, high level, Bluetooth or low level in the pop-up window.
2. Auxiliary sound source (audio mixing):
 - a. Click the button below the auxiliary sound source, and select the auxiliary sound source: digital, high level, Bluetooth, low level or turn off in the pop-up window.
 - b. The greater the attenuation of the main sound source is, the lower the main volume is. The adjustable values are 0%, 30%, 50%, 80% or 100%, and the default value is 0%.

* The auxiliary sound source cannot be superimposed with the current input sound source, otherwise the auxiliary sound source will be invalid.

Master Volume Setting

The master volume can be adjusted by dragging the fader or clicking "+" or "-" button. The adjusting range is: 0-35, and the default value is 27. Click the master volume horn button [🔊] to set the master volume to mute [🔇], and click again to cancel mute (the mute will be automatically canceled when the master volume is adjusted).

Sound Effect Setting

There is storage space for six groups of preset sound effects inside the machine. Slide left and right to select the preset sound effect data to be saved or called.

Delay Interface

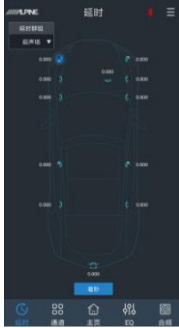

Click the delay value of the corresponding channel, and push the fader left and right in the pop-up window to adjust the delay, or click "+" and "-" to adjust the delay.

1. Delay groups: front sound field, rear sound field, overall sound field or none.
2. Delay unit: millisecond, centimeter and inch.
3. Adjusting range: 0.000-20.000 milliseconds, 0-692 centimeters, and 0-273 inches.

Channel Interface



Frequency Divider Setting

1. Type: Linkwitz, Butterworth or Bessel.
2. Frequency: set the frequency by sliding left and right or clicking "+" and "-". The adjusting range is 20Hz to 20000Hz.
3. Slope: 6dB/Oct, 12dB/Oct, 18dB/Oct, 24dB/Oct, 30dB/Oct, 36dB/Oct, 42dB/Oct or 48dB/Oct.

* When the slope is 6dB/Oct, the type is displayed as "Empty".

Output Channel Setting

1. Type: click the output channel type button **【前置全频】**, and select the channel type in the pull-down menu. Front end high frequency, medium frequency, low and medium frequency, low frequency and full frequency for choice; rear end high frequency, medium frequency, low and medium frequency, low frequency and full frequency for choice; and in the middle, there are front-mid high frequency, front-mid medium frequency, rear-mid high frequency and rear-mid medium frequency for choice; as for ultralow, there are left ultralow frequency, right ultralow frequency and ultralow frequency for choice; and as for surround, there are left surround and right surround for choice.
2. Volume: set the channel volume by pushing the fader. The adjusting range is -60dB to 6dB, and the default value is 0dB.
3. Mute: click the volume horn button **【静音】** to mute **【静音】** the channel.
4. Phase position: click the positive phase button **【正相】** or reverse phase button **【反相】** to switch between positive phase/reverse phase.
5. Joint debugging: click the joint debugging button **【EQ 联调】**. The optional joint debugging mode includes "copy EQ from left to right" or "copy EQ from right to left".
6. Lock: click the lock button **【锁定】** to lock the current channel type.
7. Reset: click the reset button **【重置】**. In the pop-up window, click the clear button **【清空】** to set the current channel type as empty, and click the default button **【默认】** to set the current channel type as ex-factory state.

EQ Interface

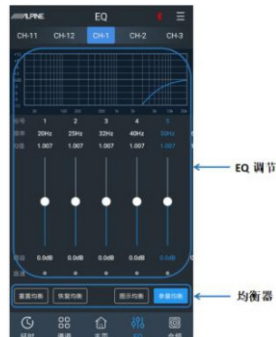

Channel EQ has two interfaces: graphic equalization and parametric equalization.



Graphic equalization interface



Parametric equalization interface

There are 31 sections of EQ that can be adjusted. Drag the fader up and down or click the gain value to adjust the gain in the pop-up gain adjusting box by dragging the fader left and right or “+” and “-”; click Q value and adjust the Q value in the pop-up Q value adjusting box by dragging the fader left and right or “+” and “-”; and click the frequency value and adjust the frequency in the pop-up frequency adjusting box by dragging the fader left and right or “+” or “-”.

1. Frequency adjusting range: 20Hz to 20kHz;
2. Q value adjusting range: 0.404 to 28.852; and
3. Gain adjusting range: -12.0dB to +12.0dB.

When EQ is adjusted, that is the through equalization button **【通过均衡】** appears, click “Through Equalization” to disable all the equalizers of the current channel; and click restore equalization button **【重置均衡】** to enable all the equalizers of the current channel to return to the previous startup state. Click reset equalization button **【重置均衡】**, and the parameters of all the equalizers of the current channel return to their initial state: Q value is 1.007 and gain is 0.0dB.

Click parametric equalization button **【参数均衡】** to switch “graphic equalization” into “parametric equalization”, and click graphic equalization button **【显示均衡】** to switch the “parametric equalization” into “graphic equalization”.

** Under the graphic equalization interface, the gain is adjustable and the frequency and Q value are fixed; and under the parametric equalization interface, the frequency, Q value and gain are all adjustable.*

Frequency Combination Interface



In the frequency combination interface, the volume of each sound source in the channel can be adjusted by pushing the fader left and right or “+” and “-”, thereby achieving the aim of audio mixing and frequency mixing.

** For details, please refer to “Introduction of frequency combination setting function” in the instructions of the computer software.*

Operating Instructions of Computer Software

The PXE-0850X machine can be tuned and set on the computer after the PXE-0850X software is installed.

* *This function is only for usage of manufacturers and dealers.*

Notes for Software Installation

- This software can only be used under Microsoft® Windows® operating system.
Operating system: Windows XP, Windows Vista, Windows 7, Windows 8 and Windows 10
CPU: 1.6GHz or higher
Memory card: 1GB or higher
Hard disk: 512MB or more available space
Computer screen resolution: 1280*768 or higher
- Please install the PXE-0850X computer software correctly first before connecting the PXE-0850X machine to the computer.

Main Interface

Open the PXE-0850X computer software, first enter the startup picture and then enter the tuning main interface.



Startup Picture



Main Interface

Function Menu

Before connection, the connection icon displays red [🔴]; and after successful connection, the connection icon displays green [🟢]. Menu bar: file, option and encryption function.



1. Click "File"



- Select "Load Scene File on Computer" to load the scene file previously saved on the computer as the current machine working scene.
- Select "Save as Scene File on Computer" to save the current machine working scene file to the computer for later call.
- Select "Load Whole Machine Scene" to load the whole machine file previously saved on the computer to the machine (including the current working scene, machine preset scene, output channel configuration data, etc.), that is, to copy all the machine data debugged previously to the current connected machine.
- Select "Save Whole Machine Scene" to save all the data of the current connected machine as the computer file (including the current working scene, machine preset scene, output channel configuration data, etc.) for later call when copying the whole machine.

2. Click "Option":



- Select "Frequency Combination Setting" to enter the frequency combination setting interface. The aim of audio mixing and frequency mixing can be achieved by adjusting the volume of each sound source in the channel.
 - Select "Firmware Update", select the upgrade file in the pop-up dialog box, and then click "Update" button to upgrade the firmware. The upgrade progress reaches 100%, indicating that the firmware has upgraded successfully. After the update, the machine will restart automatically.
-
- Select "Restore Ex-factory Setting" to restore the data of all settings in the machine to ex-factory state.
 - Select "Language" to switch between Chinese and English.

- e. Select "About" to view the device version.



- 3. Click "Encrypt":

Enter a 6-digit encrypted password in the pop-up dialog box to encrypt the already tuned sound effect data. The EQ frequency, Q value & gain, delay, channel volume, phase position and other data can be encrypted.

Encryption is only carried out for the currently used single group sound effect data, not all the data of the whole machine. The encrypted sound effect data can be saved as preset sound effect or computer file.



Click "Decrypt" to enter the correct password to decrypt the encrypted data; and on the decryption interface, click "Clear Data" to remove by one key the encryption state and restore the data to factory state.



Sound Source Selection



1. Main sound source: click the button on the right side of the main sound source, and select the main sound source: digital, high level, Bluetooth or low level in the pop-up window.
2. Auxiliary sound source (audio mixing):
 - a. Click the button on the right side of the auxiliary sound source, and select the auxiliary sound source: digital, high level, Bluetooth, low level or turn off in the pop-up window.
 - b. The greater the attenuation of the main sound source is, the lower the main volume is. The adjustable values are 0%, 30%, 50%, 80% or 100%, and the default value is 0%.

* When the current sound source mode is selected, the superposition of this sound source mode is not allowed, otherwise the auxiliary sound source will be invalid.



Main sound source Auxiliary sound source

Master Volume Setting

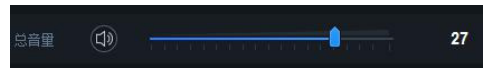

The master volume can be adjusted by pressing the left mouse button to drag the fader left and right or rolling the mouse wheel. The adjusting range is: 0-35, and the default value is 27. Click the master volume horn button [喇叭] to set the master volume to mute [静音], and click again to cancel mute (the mute will be automatically canceled when the master volume is adjusted).

Sound Effect Setting

There is storage space for six groups of preset sound effects inside the machine. Click the call button [调用] or save button [保存] to select the six groups of preset sound effect data.



Output Channel Type, Mute and Joint Debugging Setting



1. Type: click output channel type button [输出通道], and select the channel type in the pull-down menu.

Front end high frequency, medium frequency, low and medium frequency, low frequency and full frequency for choice; the rear end high frequency, medium frequency, low and medium frequency, low frequency and full frequency for choice; and in the middle, there are front-mid high frequency, front-mid medium frequency, rear-mid high frequency and rear-mid medium frequency for choice; as for ultralow, there are left ultralow frequency, right ultralow frequency and ultralow frequency for choice; and as for surround, there are left surround and right surround for choice.

- Mute: click the volume horn button to mute the channel.
- Joint debugging: click the joint debugging button . The optional joint debugging mode includes "copy EQ from left to right" or "copy EQ from right to left".
- Lock: click the lock button to lock the current channel type.
- Reset: click the reset button . In the pop-up window, click the clear button to set the current channel type as empty, and click the default button to set the current channel type as ex-factory state.

Channel Delay, Phase Position and Volume Setting



Channel Setting

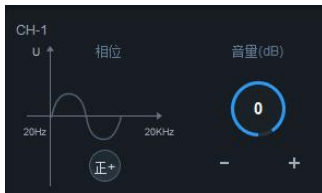

Phase Position and Volume

- Click the horn to enter the delay adjusting region. The delay can be adjusted by directly inputting values, rolling the mouse wheel and pressing the up and down buttons on the keyboard. In the delay display region, the delay can be adjusted by rolling the mouse wheel, pressing the up and down keys on the keyboard, directly dragging the fader and clicking "+" and "-".

- Delay group: front sound field, rear sound field, overall sound field or none.
 - Delay unit: millisecond, centimeter and inch.
 - Adjusting range: 0.000-20.000 milliseconds, 0-692 centimeters, and 0-273 inches.
- Volume: the channel volume can be adjusted by directly inputting values, rolling the mouse wheel and pressing the up and down keys on the keyboard. The adjusting range is -60dB to 6dB, and the default value is 0dB.
 - Phase position: click the positive phase button or the reverse phase button to switch between positive phase/reverse phase.

Frequency Divider Setting



- Type: Linkwitz, Butterworth or Bessel.
- Frequency: the frequency can be adjusted by directly inputting values, rolling the mouse wheel, pressing the up and down keys on the keyboard or clicking "H" or "L" on EQ and pressing on the left mouse button to drag. The adjusting range is 20Hz to 20000Hz.
- High-pass switch: when the frequency is 20Hz, the high-pass switch is in off state ; and when the frequency is more than 20Hz, the high-pass switch is in on state .
- Low-pass switch: when the frequency is 20kHz, the low-pass switch is in off state ; and when the frequency is more than 20kHz, the low-pass switch is in on state .
- Slope: 6dB/Oct, 12dB/Oct, 18dB/Oct, 24dB/Oct, 30dB/Oct, 36dB/Oct, 42dB/Oct or 48dB/Oct.

* When the slope is 6B/Oct, the type is displayed as "Empty".

Channel EQ Setting

Channel EQ has two interfaces: graphic equalization and parametric equalization.

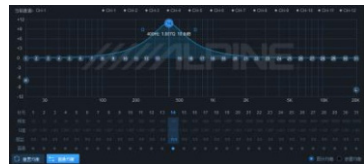

Graphic equalization interface

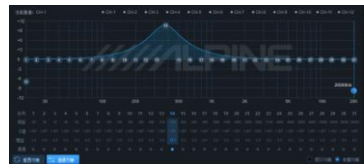





Parametric equalization interface

There are 31 sections of EQ that can be adjusted. When the mouse moves to the serial number position, press on to drag up and down to adjust the gain of the equalizer and drag left and right to adjust the frequency of the equalizer; and when the mouse moves to the small blue boxes on the left and right, press on to pull left and right to adjust the Q value of the equalizer. The frequency, Q value and gain can also be set by directly inputting values, rolling the mouse wheel and pressing the up and down keys on the keyboard.

1. Frequency adjusting range: 20Hz to 20kHz;
2. Q value adjusting range: 0.404 to 28852; and
3. Gain adjusting range: -12dB to +12dB.

When EQ is adjusted, that is the through equalization button  appears, click the "Through equalization" or through "small dot" to disable all the equalizers of the current channel; and click the

restore equalization button  to enable all the equalizers of the current channel to return to the previous startup state. Click the reset equalization button , and the parameters of all the equalizers of the current channel return to their initial state: the frequency is uniformly distributed, Q value is 1.007 and gain is 0.0dB.

Click parametric equalization button  to switch "graphic equalization" into "parametric equalization", and click graphic equalization button  to switch the "parametric equalization" into "graphic equalization".

** Under the graphic equalization interface, the gain is adjustable and the frequency and Q value are fixed; and under the parametric equalization interface, the frequency, Q value and gain are all adjustable.*

Frequency Combination Setting Function Introduction

After the sound source signal set by the PXE-0850X machine enters into the audio processor, the frequency is divided into the volume of each output channel, thereby achieving the aim of audio mixing and frequency mixing by adjusting the volume of each sound source in the channel. Under the passive input mode, the frequency division is set by the PC terminal; and under the active input mode, the frequency division is set by the host of the original vehicle itself.

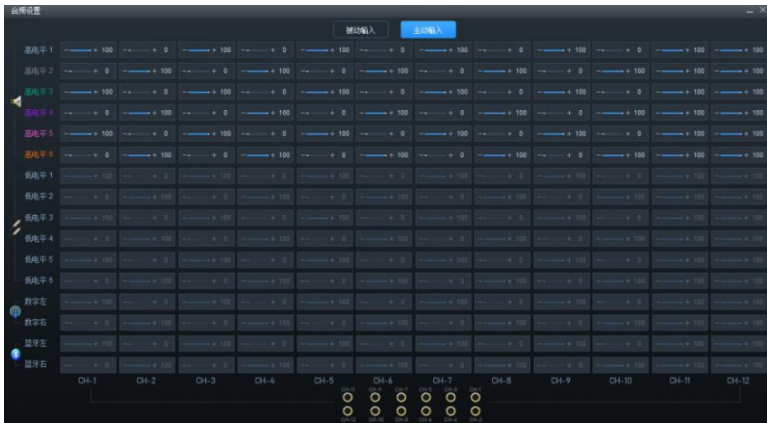

Example 1: the low level of the host of the original vehicle and the low level of the external CD machine are input at mixed frequency, and the stereo is output at full frequency.

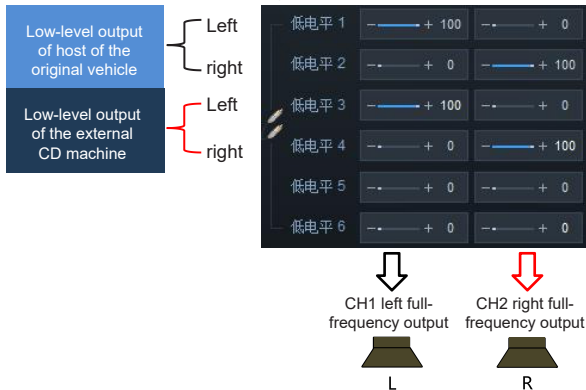

Example 2: the high level of the host of the original vehicle is input at mixed frequency of active two divided-frequency, and the stereo is output at full frequency.

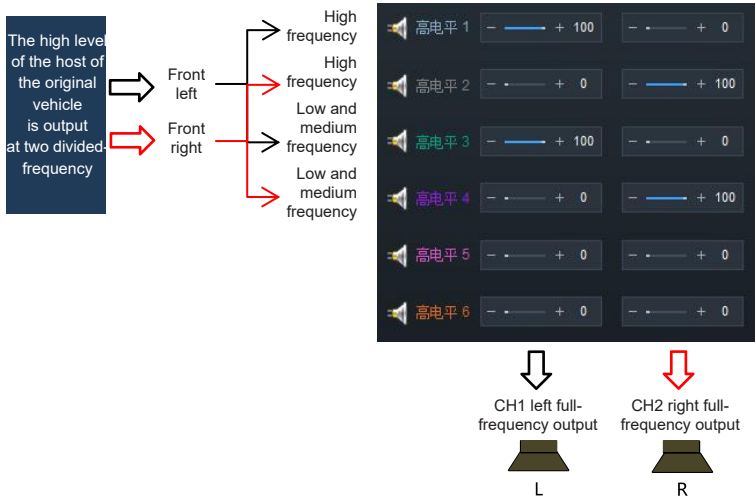

Example 3: the high level of the host of the original vehicle is input at mixed frequency of active three divided-frequency, and the stereo is output at full frequency.

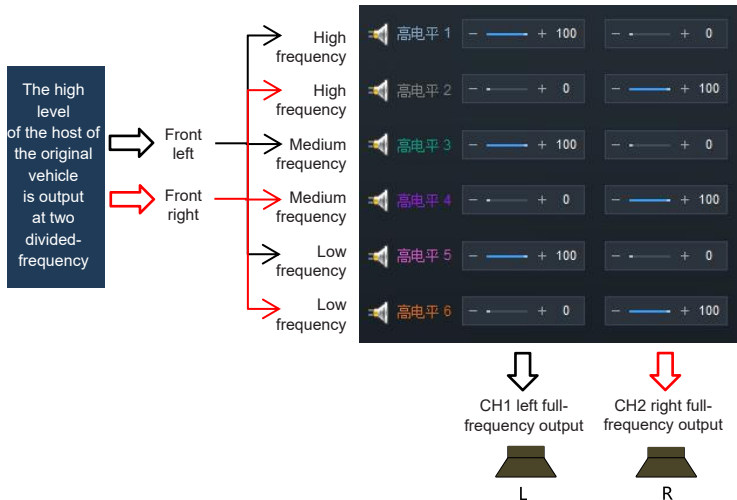

Operating Instructions of Wire Controller

The PXE-0850X machine can adopt the PXE-0850X wire controller for tuning and setting. Please connect the wire controller to the machine correctly before usage and make sure its normal start.

Note: the wire controller and the tuning software cannot be used at the same time.

Startup Picture

After the wire controller is started, the dynamic startup picture is displayed, as shown in FIG. 1.



FIG. 1

Master Volume (VOLUME)

After start-up, enter into the main interface of the wire controller—the master volume interface (VOLUME), as shown in FIG. 2-1. Rotate the button to adjust the master volume. Rotate clockwise to increase the volume and anticlockwise to reduce the volume. The adjusting range is 0 to 35. Short press the rotary knob on the master volume interface to enter into the mute interface, as shown in FIG. 2-2.

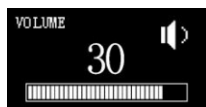

FIG. 2-1



FIG. 2-2

Main Sound Source (MAIN SOURCE)

Press on the rotary knob for 2 to 5 seconds on the master volume interface to enter into the main sound source interface (MAIN SOURCE), as shown in FIG. 3. Rotate the button to select the main sound source: digital (SPDIF), high level (Hi.L), Bluetooth (BT) and low level (AUX). When the Bluetooth and the high level or low level signal are connected simultaneously, the Bluetooth will directly serve as the main sound source by default. After no operation for about 5 seconds, it will automatically exit this interface and return to the main interface of the wire controller (master volume interface).



FIG. 3-1



FIG. 3-2

Auxiliary Sound Source (MIX SOURCE)

Short press the rotary knob on the main sound source interface to enter into the auxiliary sound source

interface (MIX SOURCE), as shown in FIG. 4-1. Rotate the button to select the auxiliary sound source: digital (SPDIF), high level (Hi.L), Bluetooth (BT), low level (AUX) and turn off (OFF). After no operation for about 5 seconds, it will automatically exit this interface and return to the main interface of the wire controller (master volume interface).



FIG. 4-1



FIG. 4-2

Bass Volume (SUB W)

Short press the rotary knob on the auxiliary sound source interface to enter into the bass volume adjusting interface (SUB W), as shown in FIG. 5. Rotate the rotary knob of the wirecontroller to adjust the bass volume of the machine. Rotate clockwise to increase the bass volume and anticlockwise to reduce the bass volume. The adjusting range is 0 to 15. After no operation for about 5 seconds, it will automatically exit this interface and return to the main interface of the wire controller (master volume interface).

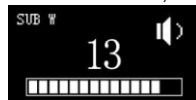

FIG. 5

Preset Sound Effect (PRESET)

Short press the rotary knob on the bass volume interface to enter into the preset sound effect interface(PRESET), as shown in FIG. 6-1. The number behind PRESET represents the sound effect data called by the machine currently.

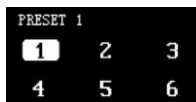

FIG. 6-1

The required sound effect data can be selected by the rotary knob. When the cursor moves to the corresponding number, short press the rotary knob to call directly, as shown in FIG. 6-2. After completing the call, it will automatically exit this interface and return to the main interface of the wire controller (master volume interface).



FIG. 6-2

Specification Parameter

Dynamic range	≥110dB
Signal to noise ratio (RCA)	≥100dB
Ground noise	High level: 70uVrms; RCA: 7.66uVrms
Channel separation degree	≥80dB
Total harmonic distortion	≤0.05%
Input voltage	High level: 26Vpp; RCA: 6.5Vpp
Output voltage	6.5Vpp
Rated power	8CH×25W (4Ω, 14.4V, 1kHz, 10%THD)
Maximum power	8CH×50W (4Ω, 14.4V, 1kHz, 10%THD)
Input/output sensitivity (RCA)	1: 1.125 (without power amplification)
Frequency response	20Hz to 20kHz
System sampling rate	48kHz/24bit
Input impedance	High level: 100Ω; RCA: 20kΩ
Output impedance	51Ω
Working voltage	9-16V
Static current	≤2.3mA (off state)
Standby power consumption	≤0.1W
REM start input	High level (H1-/H1+), ACC for choice
REM start output	12V (0.2A)
Startup time	10s
Environment temperature	-20~60°C
Storage temperature	-40~85°C
Gross weight	1.7kg
Size of host	210mm×190mm×45mm
Size of wire controller	92.5mm×48.1mm×24mm

Function Parameter

Input signal	6 channel high level, 6 channel RCA audio , high-definition Bluetooth, optical fiber, coaxial
Output signal	8 channel high level, 12 channel RCA audio
Output channel signal gain	Range: mute, -60dB ~ +6dB
Output signal equalizer	Type: parametric equalization and graphic equalization Frequency: 20Hz ~ 20kHz, resolution 1Hz Q value (slope): 0.404 ~ 28.852 Gain: -12.0dB ~ +12.0dB, resolution 0.1dB
Output signal frequency divider	Each output channel is equipped with a multi-stage high-low pass independent filter, Filtering type: Linkwitz, Butterworth or Bessel Filtering frequency-dividing point: 20Hz~ 20kHz, resolution 1Hz Filtering slope: 6dB/Oct~48dB/Oct
Output phase position	Positive phase or reverse phase (+/-)
Output delay	0.000~20.000Ms, 0~692cm, 0~273inch
Preset Sound Effect	The machine can save 6 groups of preset sound effect data

有害物质成分

产品中有害物质或元素的名称及含量

部件名称	有害物质或元素					
	铅 (Pb)	汞 (Hg)	镉 (Cd)	六价铬 (Cr(VI))	多溴联苯 (PBB)	多溴二苯醚 (PBDE)
电路板组件	×	○	○	○	○	○
壳体组件	○	○	○	○	○	○
显示组件	×	○	○	○	○	○
配件	×	○	○	○	○	○

本表格依据 SJ/T 11364 的规定编制。

○：表示该有害物质在该部件所有均质材料中的含量均在 GB/T 26572 规定的限量要求以下。

×：表示该有害物质至少在该部件某一均质材料中的含量超出 GB/T 26572 规定的限量要求。

打“×”的部件，其含量超出是因为目前业界还没有成熟的可替代的技术。

维修站信息

- 关于维修的咨询，请参照下列“维修站信息”。
- 维修站名称、电话号码、地址会有变更的情况发生。

序号	维修站	地址	邮编	电话
1	北京维修站	北京市朝阳区管庄西里甲 3 号巨果商务园 6 栋 609 室	100024	010-65750660
2	上海维修站	上海市普陀区同普路 158 弄 12 号 1 楼	200062	021-62605645
3	广州维修站	广州市白云区京溪路善和街 3 号	510510	186-6505-9713
4	郑州维修站	郑州市人民路工三街 24 号楼 1 号	450000	0371-66222388
5	昆明维修站	昆明市龙泉路泰阳欣城铺面 407, 408 号	650031	0871-65116201
6	南京维修站	南京市栖霞区经五路兴都晴轩中 1 幢 108 室	210003	025-86630368
7	杭州维修站	杭州市富阳区文教路 80-6 号	311400	138-5819-6041 189-5751-6008
8	厦门维修站	厦门市后埭溪路 248 号六、七、八号店面	361004	0592-5170118
9	乌鲁木齐维修站	乌鲁木齐市青年路 308 号	830002	0991-8871299
10	南昌维修站	南昌市新洲路 98 号丰源嘉会朝阳居一楼店面	330029	0791-86566758
11	成都维修站	成都市成华区驷马桥东立国际广场 B1 区 1333 号	610051	028-84397796

获取最新最详细的维修站信息，请登录 www.alpine.com.cn 查询。